

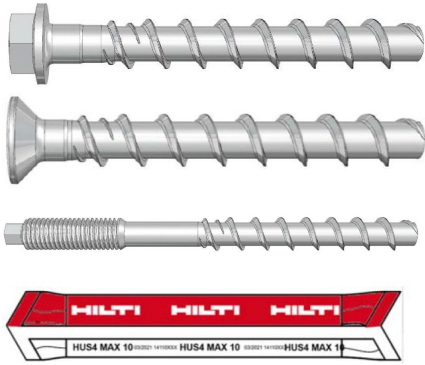

Hilti HUS4 BONDED SCREW ANCHOR

Technical Datasheet





Update: Aug - 22







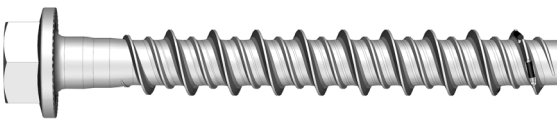



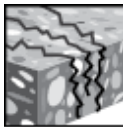

HUS4 Bonded screw anchor

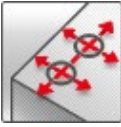
Ultimate performance screw anchor for single point fastening

Anchor version		Benefits
	HUS4-H(F) (10-16)*	- High productivity - less drilling and fewer operations than with conventional anchors
	HUS4-C (10)	- ETA approval for cracked and non-cracked concrete - ETA approval for Seismic C1 and C2**
	HUS4-A(F) (10 and 14)	- ETA approval for adjustability (unscrew-rescrew)** - Smaller edge and spacing distance
	HUS4-HR (10 and 14)	- One embedment at the level of h.nom3 of HUS4 for maximum performance - No cleaning allowed size 10 to 16
	HUS4-CR (10)	- HUS4-HF and HUS4-AF with multilayer coatings for additional corrosion protection - Through fastening with H, A and C head
	HUS4-MAX capsule	- Pre-fastening with A head

Base material	Load conditions
 <p>Concrete (non-cracked)</p>  <p>Concrete (cracked)</p>	 <p>Static / quasi-static</p>  <p>Seismic ETA-C1/C2</p>  <p>Fire resistance</p>
Installation conditions	Other information
 <p>Small edge distance and spacing</p>	 <p>European Technical Assessment</p>  <p>CE conformity</p>  <p>PROFIS Engineering software</p>

Approvals / certificates

Description	Authority	No. / date of issue
European Technical Assessment including fire data	DIBt	ETA-18/1160 / 27-07-2022

*HUS4-HF not available in size 12

**Not available for HUS4-HR and HUS4-CR

Static and quasi-static loading data (for a single anchor)

All data in this section applies to:

- Correct setting (See setting instruction)
- No edge distance and spacing influence
- Steel failure
- Minimum base material thickness
- Concrete C 20/25, $f_{ck,cube} = 25 \text{ N/mm}^2$

Anchor size		10		12	14		16
Type	HUS4-	H(F), C, A(F)	HR, CR	H	H(F), A(F)	HR	H
Nominal embedment depth	h_{nom} [mm]	h_{nom3}		h_{nom3}	h_{nom3}		h_{nom3}
		85	90	100	115	110	130

Characteristic resistance

Anchor size		10		12	14		16
Type	HUS4	H(F), C, A(F)	HR, CR	H	H(F), A(F)	HR	H
		h_{nom3}		h_{nom3}	h_{nom3}		h_{nom3}
Non-cracked concrete							
Tension N_{Rk}	[kN]	38,0	40,0	49,2	60,7	56,8	72,9
Shear V_{Rk}	[kN]	32,0	33,0	44,9	62,0	77,0	73,1
Cracked concrete							
Tension N_{Rk}	[kN]	24,0	24,0	34,4	42,0	39,7	51,0
Shear V_{Rk}	[kN]	32,0	33,0	44,9	62,0	77,0	73,1

Design resistance

Anchor size		10		12	14		16
Type	HUS4	H(F), C, A(F)	HR, CR	H	H(F), A(F)	HR	H
		h_{nom3}		h_{nom3}	h_{nom3}		h_{nom3}
Non-cracked concrete							
Tension N_{Rd}	[kN]	25,3	26,7	32,8	40,4	37,8	48,6
Shear V_{Rd}	[kN]	25,6	22,0	35,9	49,6	51,3	58,5
Cracked concrete							
Tension N_{Rd}	[kN]	16,0	16,0	23,0	28,0	26,5	34,0
Shear V_{Rd}	[kN]	25,6	22,0	35,9	49,6	51,3	58,5

Recommended loads

Anchor size		10		12	14		16
Type	HUS4	H(F), C, A(F)	HR, CR	H	H(F), A(F)	HR	H
		h_{nom3}		h_{nom3}	h_{nom3}		h_{nom3}
Non-cracked concrete							
Tension N_{Rec}	[kN]	18,1	19,0	23,4	28,9	27,0	34,7
Shear V_{Rec}	[kN]	18,3	15,7	25,7	35,4	36,7	41,8
Cracked concrete							
Tension N_{Rec}	[kN]	11,4	11,4	16,4	20,0	18,9	24,3
Shear V_{Rec}	[kN]	18,3	15,7	25,7	35,4	36,7	41,8

a) With overall partial safety factor for action $\gamma = 1,4$. The partial safety factors for action depend on the type of loading and shall be taken from national regulations.

Seismic loading data (for single anchor)

All data in this section applies to:

- Correct setting (See setting instruction)
- No edge distance and spacing influence
- Steel failure
- Minimum base material thickness
- Concrete C 20/25, $f_{ck,cube} = 25 \text{ N/mm}^2$
- $\alpha_{gap} = 1,0$ (using Hilti seismic filling set)

Anchor size	10	12	14
Nominal anchor. depth range h_{nom} [mm]	h_{nom3} 85	h_{nom3} 100	h_{nom3} 115

Characteristic resistance in case of seismic performance category C2

Anchor size	10	12	14
with Hilti filling set ($\alpha_{gap} = 1,0$)			
Type HUS4 -	H(F), A(F)	H	H(F), A(F)
Tension $N_{Rk,seis}$ [kN]	10,7	17,2	18,2
Shear $V_{Rk,seis}$	21,5	27,2	46,5
without Hilti filling set ($\alpha_{gap} = 0,5$)			
Type HUS4 -	H(F), C, A(F)	H	H(F), A(F)
Tension $N_{Rk,seis}$ [kN]	10,7	17,2	18,2
Shear $V_{Rk,seis}$	13,7	22,5	34,4

Design resistance in case of seismic performance category C2

Anchor size	10	12	14
with Hilti filling set ($\alpha_{gap} = 1,0$)			
Type HUS4 -	H(F), A(F)	H	H(F), A(F)
Tension $N_{Rd,seis}$ [kN]	7,1	11,5	12,1
Shear $V_{Rd,seis}$	17,2	21,8	37,2
without Hilti filling set ($\alpha_{gap} = 0,5$)			
Type HUS4 -	H, HF, C, A, AF	H	H, HF, A, AF
Tension $N_{Rd,seis}$ [kN]	7,1	11,5	12,1
Shear $V_{Rd,seis}$	5,5	9,0	13,8

Characteristic resistance in case of seismic performance category C1

Anchor size	10	12	14
Type HUS4 -	H(F), C, A(F)	H	H(F), A(F)
Tension $N_{Rk,seis}$ [kN]	22,9	29,3	36,1
Shear $V_{Rk,seis}$	26,7	38,9	34,5

Design resistance in case of seismic performance category C1

Anchor size	10	12	14
Type HUS4 -	H(F), C, A(F)	H	H(F), A(F)
with Hilti filling set ($\alpha_{gap} = 1,0$) (HUS4-H and HUS4-A)			
Tension $N_{Rd,seis}$ [kN]	15,3	19,5	24,1
Shear $V_{Rd,seis}$	21,4	31,1	27,6
without Hilti filling set ($\alpha_{gap} = 0,5$)			
Tension $N_{Rd,seis}$ [kN]	15,3	19,5	24,1
Shear $V_{Rd,seis}$	10,7	15,6	13,8

Fire resistance

All data in this section applies to:

- Correct setting (See setting instruction)
- No edge distance and spacing influence
- *Steel* failure
- Minimum base material thickness
- Concrete C 20/25, $f_{ck,cube} = 25 \text{ N/mm}^2$
- Partial safety factor for resistance under fire exposure $\gamma_{M,fi}=1,0$ (in absence of other national regulations)

Characteristic and design resistance

Anchor size		10				12	14			16
Type	HUS4	H(F)	C	A(F)	HR ^{a)}	H	H(F)	A(F)	HR ^{a)}	H(F)
		h_{nom3}				h_{nom3}	h_{nom3}			h_{nom3}
Fire Exposure R30										
Tension N_{Rk}	[kN]	4,2	1,0	4,2	4,0	6,1	7,5	7,5	6,3	8,7
Shear V_{Rk}	[kN]	4,2	1,0	4,2	18,5	7,7	10,5	8,4	41,7	10,7
Fire Exposure R120										
Tension N_{Rk}	[kN]	1,7	0,6	2,1	2,4	3,1	4,4	4,3	5,0	4,5
Shear V_{Rk}	[kN]	1,7	0,6	2,1	2,4	3,1	4,4	4,3	5,4	4,5

^{a)} Values for this head configuration are based on Hilti technical data



Materials

Foil capsule HUS4-MAX size 10 to 14: resin and hardener

Marking:

HUS4-MAX size

Expiry date mm/yyyy



Material quality

Type	Material
HUS4 – H, A, C	Carbon steel, galvanized
HUS4 – HF, AF	Carbon steel, multi-layer coating ^{a)}
HUS4 – HR, CR	Stainless steel

a) Multi-layer coating provides a higher corrosion resistance compared to regular hot dip galvanized (HDG) systems with a 40µm coating thickness.

Head configuration

Type	Part	
HUS4-H HUS4-HF	Hexagonal head	
HUS4-C	Countersunk head	
HUS4-A	External thread	 Hilti HUS4-A, size 10 with external thread M12 and size 14 with external thread M16
HUS4-HR	Hexagonal head	
HUS4-CR	Countersunk head	

Fastener dimensions and marking HUS4-H(F)

Anchor size		10		12	14		16
Type	HUS4	H(F)	HR	H	H(F)	HR	H
Outer diameter of screw	d_t [mm]	12,70	12,25	14,70	16,70	16,56	18,80
Diameter of integrated	d_i [mm]	20,50	20,50	23,60	29,00	30,00	32,60
Length of the screw	L [mm]	90/305	95/130	130/150	130/150	120/135	100/205

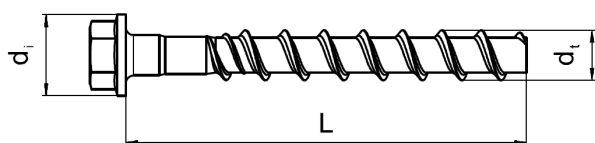

HUS4: Hilti Universal Screw 4th generation

H: Hexagonal head, galvanized

HF: Hexagonal head, multilayer coating

HR: Hexagonal head, stainless steel

10: Nominal screw diameter

100: total length of the screw

Fastener dimensions and marking HUS4-C

Anchor size		10	
Type	HUS4	C	CR
Outer diameter of the screw thread	d_t [mm]	12,70	12,25
Countersunk head diameter	d_h [mm]	21,00	21,00
Length of the screw (min/max)	L [mm]	100/120	105

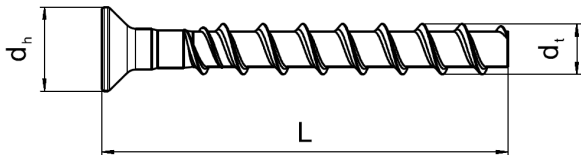

HUS4: Hilti Universal Screw 4th generation

C: Countersunk head

CR: Countersunk head, stainless steel

10: Nominal screw diameter

100: total length of the screw

Fastener dimensions and marking HUS4-A(F)

Anchor size		10	14
Type	HUS4	A(F)	A(F)
Outer diameter of the screw thread	d_t [mm]	12,70	16,70
Diameter of the metric thread	d_M [mm]	M12	M16
Length of the screw (min/max)	L [mm]	140/165	185/205

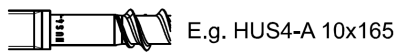
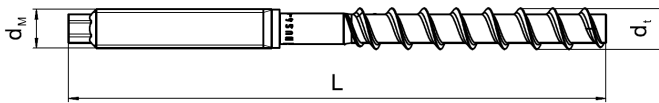

HUS4: Hilti Universal Screw 4th generation

A: Threaded head

10: Screw diameter

100: total length of the screw

8: carbon steel 8.8

K: length of the screw (more info in ETA)

Setting information

Setting details

Anchor size		10		12	14		16	
Type	HUS4	H(F), C,	HR, CR	H	H(F), A(F)	HR	H(F), A(F)	
Nominal embedment depth [mm]	[mm]	h_{nom3}	h_{nom3}	h_{nom3}	h_{nom3}	h_{nom3}	h_{nom3}	
		85	90	100	115	110	130	
Nominal diameter of drill	d_0	[mm]	10	10	12	14	14	16
Clearance hole diameter	$d_r \leq$	[mm]	14	14	16	18	18	20
Wrench size HEX head	SW1	[mm]	15	15	17	21	21	24
Wrench size Threaded head	SW1	[mm]	8	-	-	12	-	-
Wrench size for nut on threaded head	SW2	[mm]	19	-	-	24	-	-
Torx size "C" head	TX	-	50	45	-	-	65	-
Countersunk head diameter	d_h	[mm]	21	21	-	-	-	-
Depth of drill hole for cleaned hole overhead	$h_1 \geq$	[mm]	95	100	110	125	120	140
Depth of drill hole for uncleaned hole	$h_1 \geq$	[mm]	115	120	134	153	148	-

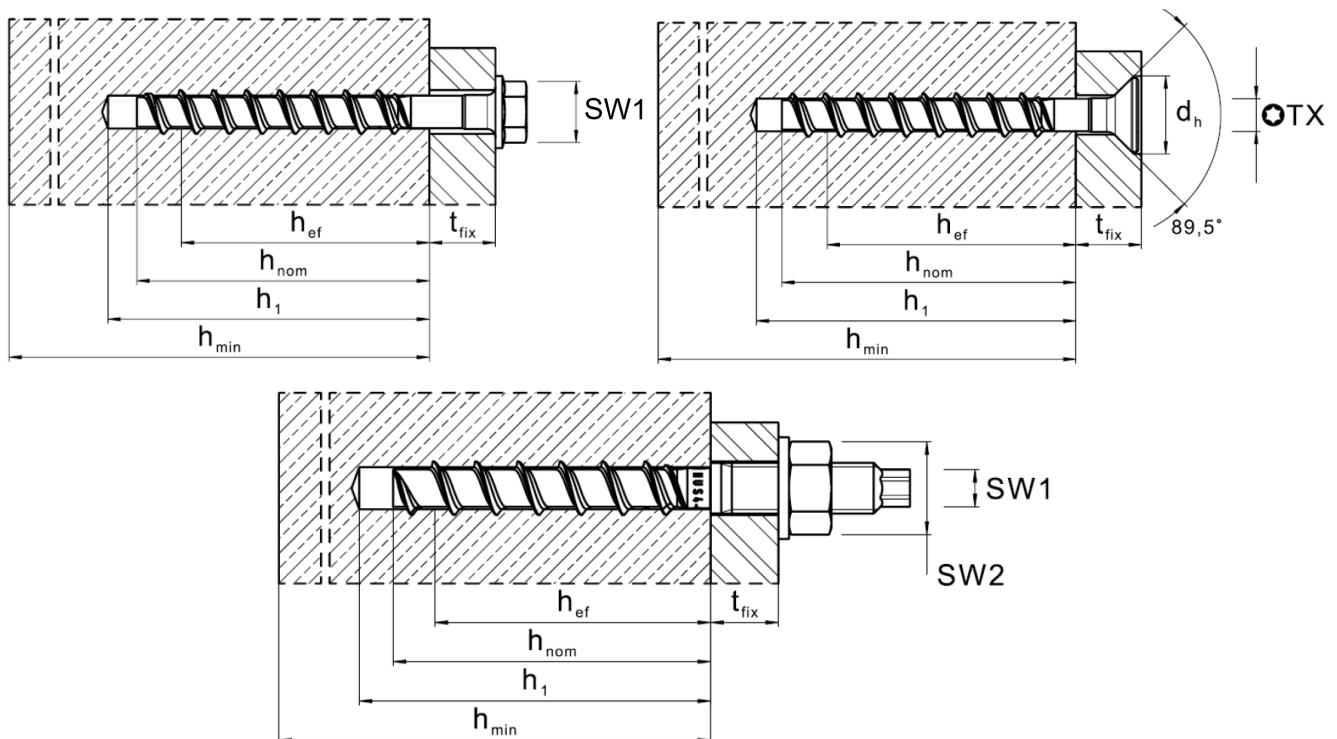

Installation equipment table (HUS4 H(F), C, A(F)):

Anchor size	10	12	14	16
Type	HUS4- H(F), C, A(F)	H(F)	H(F), A(F)	H(F)
Rotary hammer	TE4 – TE30			
Diamond drilling rig	DD-30			
Drill bit for concrete	TE-CX 10	TE-CX 12 TE-CD 12	TE-CX 14 TE-CD 14	TE-CX 16
Diamond drilling core bits	SPX-T 10	SPX-T 12	SPX-T 14	-
Socket wrench insert for hex screw	SI-S ½" 15S SI-S ¾" 15S	SI-S ½" 17S SI-S ¾" 17S	SI-S ½" 21S SI-S ¾" 21S	SI-S ½" 24S SI-S ¾" 24S
Socket wrench insert for threaded head screw	SI-S ½" 8S SI-S ¾" 8S	-	SI-S ½" 12S SI-S ¾" 12S	-
Check gauge for reusability ^{a)}	HRG 10	HRG 12	HRG 14	HRG 16
Torx bit for countersunk	S-SY TX50	-	-	-
Setting tool for cracked and un-cracked concrete	SIW 6AT-A22 ½" SIW 4AT-22 ½" SIW 22T-A ½", ¾" SIW 6-22 ½", SIW 8-22 ½" gear 1 SIW 9-A22 ¾"	SIW 22T-A ½", ¾" SIW 6-22 ½", SIW 8-22 ½" SIW 9-A22 ¾"		

a) For HUS4-A and HUS4-H

Installation equipment table (HUS4 HR, CR):

Anchor size	10	14
Type	HUS4- HR, CR	HR
Rotary hammer	TE 2 – TE 30	
Drill bit	TE-CX4 (SDS PLUS) 10/22	TE-CX4 (SDS PLUS) 14/22
Socket wrench insert	SI-S 13 ½" (S)	SI-S 13 ½" (S)
Torx (CR type only)	S-SY TX 50	-
Impact screw driver ¹⁾	SIW 6AT-A22 ½" SIW 4AT-A22 ½" SIW22T-A ½", ¾" SIW6-22 gr.2 ½"	SIW22T-A ½" SIW6-22 gr.2 ½" SIW8-22 gr.1 ½" SIW9-22 ¾"

Setting parameters

Anchor size	10	12	14	16		
Type	HUS4 H(F), C, A(F)	HR	H	H(F), A(F)	HR	H
Nominal embedment depth h_{nom} [mm]	85	90	100	115	110	130
Minimum base material thickness h_{min} [mm]	140	140	160	200	160	195
Minimum spacing s_{min} [mm]	40	50	50	60	60	90
Minimum edge distance c_{min} [mm]	40	50	50	60	60	65
Critical spacing for splitting failure $s_{cr,sp}$ [mm]	272	351	340	423	407	507
Critical edge distance for splitting failure $c_{cr,sp}$ [mm]	136	176	170	213	204	254
Critical spacing for concrete cone failure $s_{cr,N}$ [mm]	255	270	300	345	330	390
Critical edge distance for concrete cone failure $c_{cr,N}$ [mm]	128	135	150	173	165	195

For spacing (edge distance) smaller than critical spacing (critical edge distance) the design loads have to be reduced (see system design resistance).



Critical spacing and critical edge distance for splitting failure apply only for non-cracked concrete. For cracked concrete only the critical spacing and critical edge distance for concrete cone failure are decisive.

Storage and transport temperature range:

-20°C to +25°C

Temperature in the base material:

at installation

-10 °C to +40 °C

in-service

Temperature range I: -40 °C to +120 °C

(max. long term temperature +72 °C and max. short term temperature +120 °C)

Max short term base material temperature

Short-term elevated base material temperatures are those that occur over brief intervals, e.g. as a result of diurnal cycling.

Max long term base material temperature

Long-term elevated base material temperatures are roughly constant over significant periods of time

Setting instructions

*For detailed information on installation see instruction for use given with the package of the product

Setting instruction - H(F), C, A(F), HR, CR

1a. Hammer drilling:

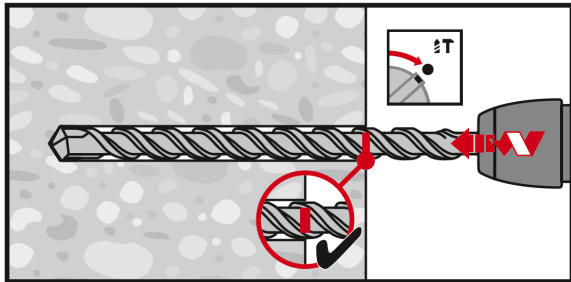

1b. Hollow drill bit (HUS4-H(F) and HUS4-C(F)):

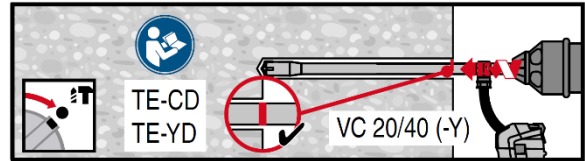

2a. Cleaning:

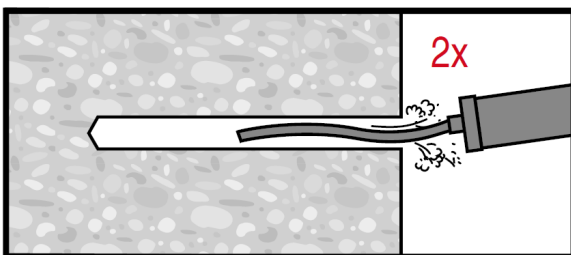

Cleaning needed in downward and horizontal installation direction with drill hole depth $h_{nom} + 10\text{mm}$

Not needed if hammer drilling with Hilti hollow drill bit.

2b. Non-cleaning – 3x ventilation

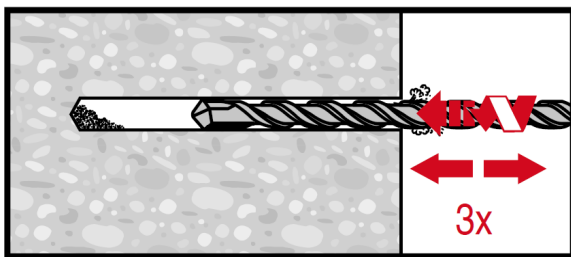

No cleaning is allowed in upward installation direction. No cleaning is allowed in downward and horizontal installation direction when 3x ventilation¹⁾ after drilling is executed.

Drill hole depth $h_{nom} + 10\text{ mm} + 2 * d_0$

¹⁾ moving the drill bit in and out of the drill hole 3 times after the recommended drilling depth h_1 is achieved. This procedure shall be done with both revolution and hammer functions activated in the drilling machine. For more details read the relevant installation instruction (MPII).

3. Insert capsule in borehole

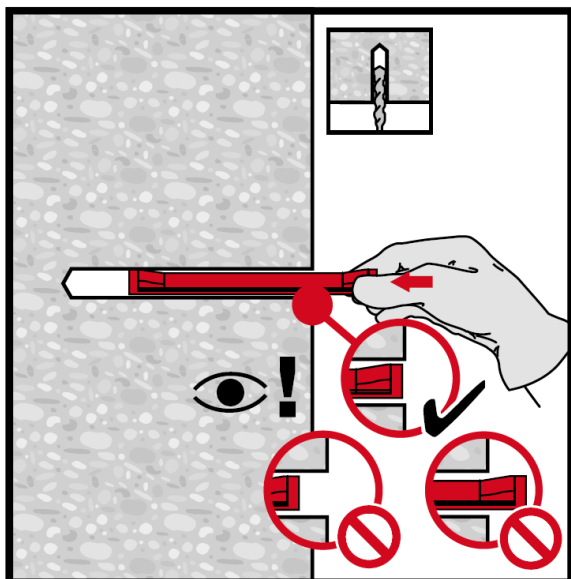

4. Setting by impact screw driver

(H(F), C, HR, CR)

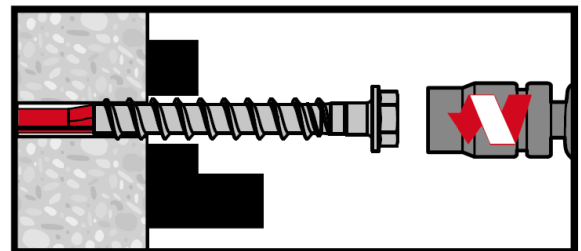

A(F)

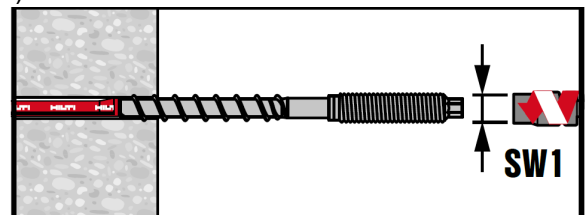

5a. Setting check – H(F), C, HR, CR

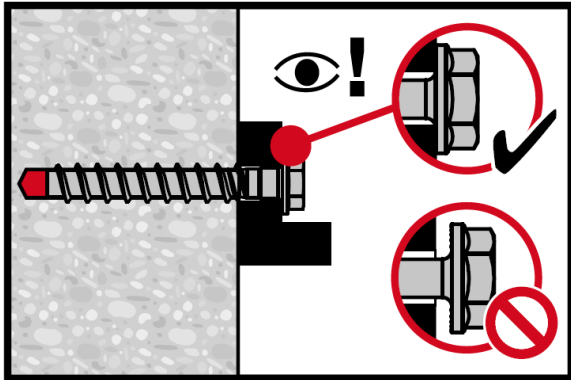

5b. load anchor – A(F)

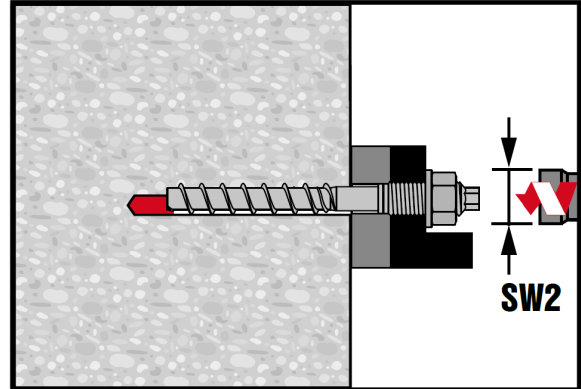

Optional – screw adjustability (only H(F), C, A(F) versions)

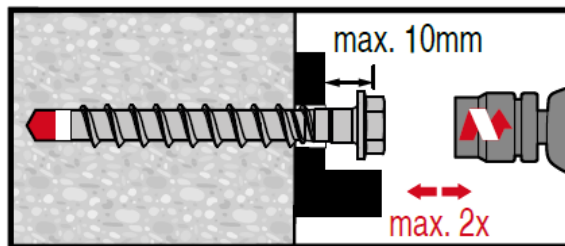

Full removability and reusability of the fastening point (H(F), C, A(F))

1. Wait at least 24h after first installation:

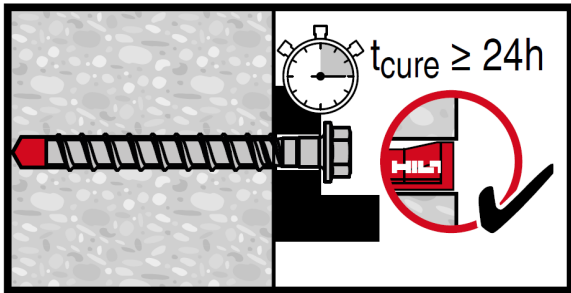

2. remove completely using setting tool:

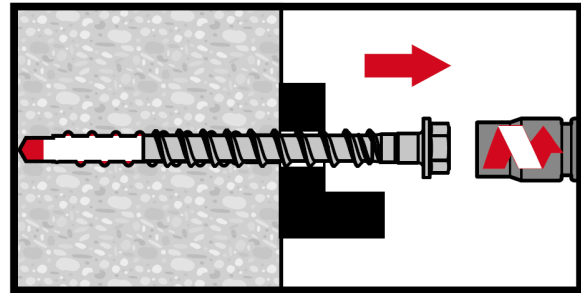

3. Re-insert in borehole by hand:

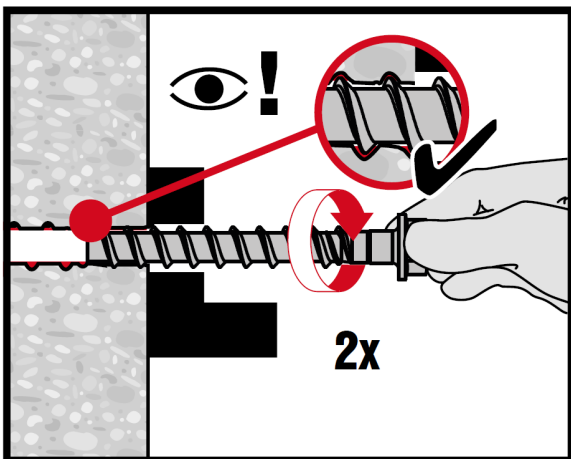

4. Complete setting by impact screw driver:

