

A4 316 Equivalent Corrosion Resistance

0-1km

Hilti Corrosion handbook / DFTM

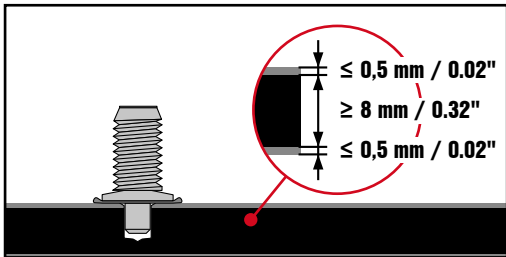

	Use with				
X-BT-GR M8/7 SN 8	✓				

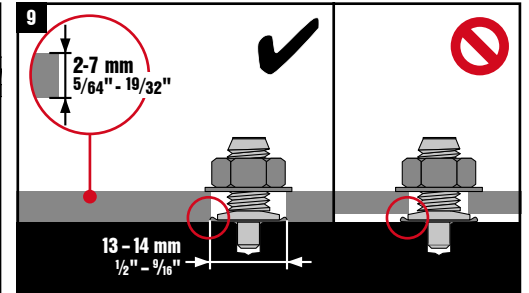
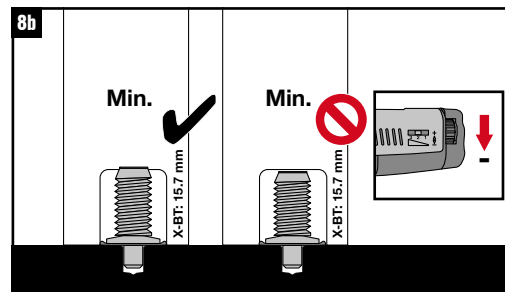
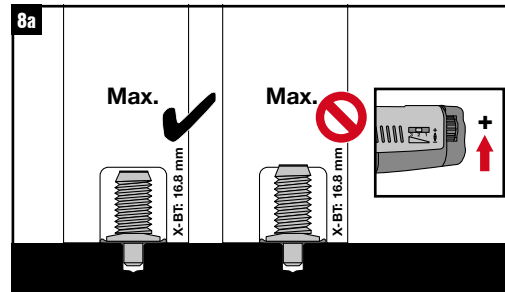
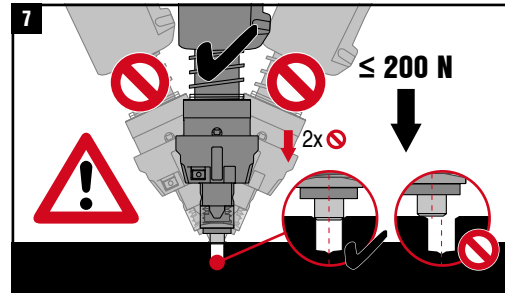
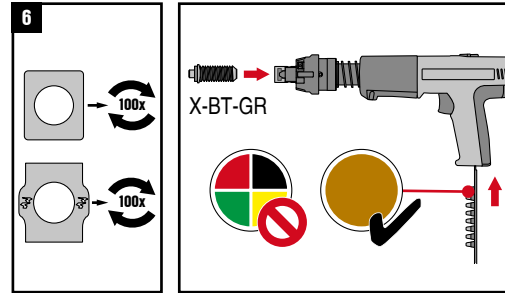
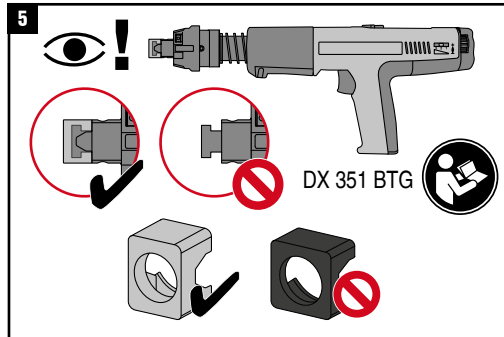
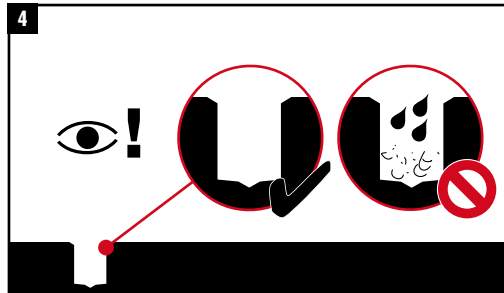
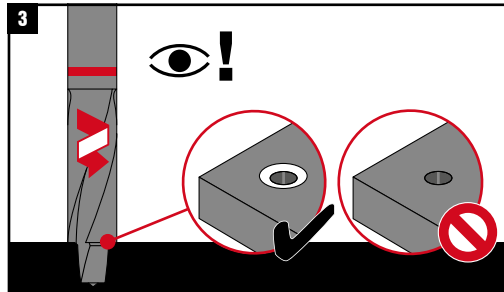
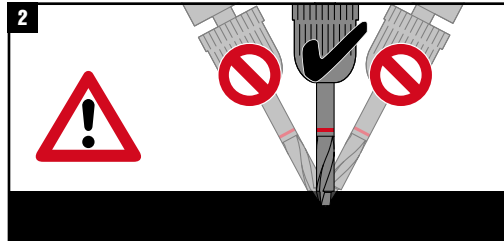
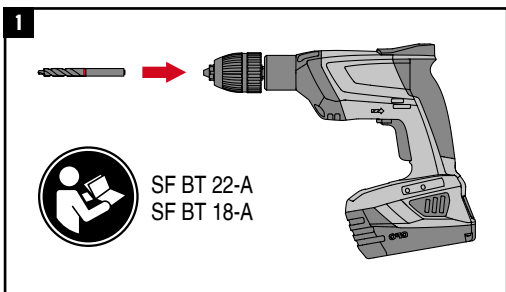

10A

X-BT 1/4''
20 Nm / 14.8 lb-ft

1

S-NS13 C
95/3 3/4''

2

T_{inst} = 16-20 Nm

10B

	3	13
	4	11
	2	11
	1!	1!

T_{inst} = 16-20 Nm

A4 316 Equivalent Corrosion Resistance

0-1km

Hilti Corrosion handbook / DFTM

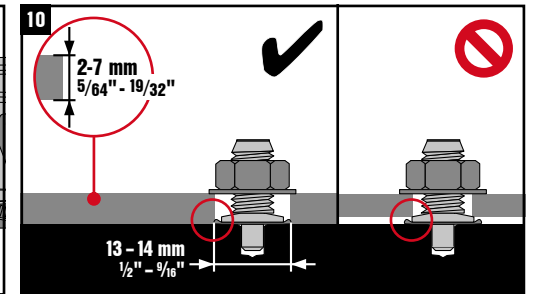
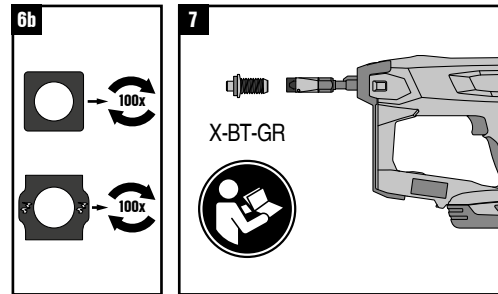
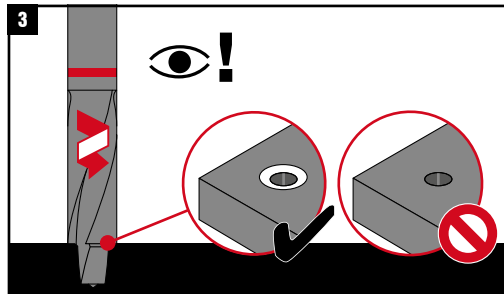
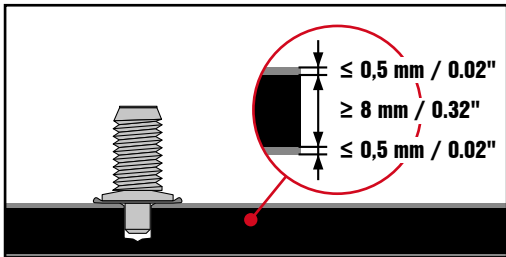
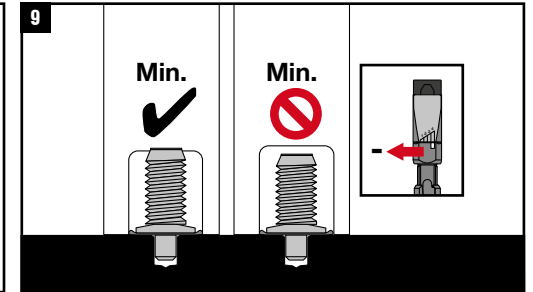
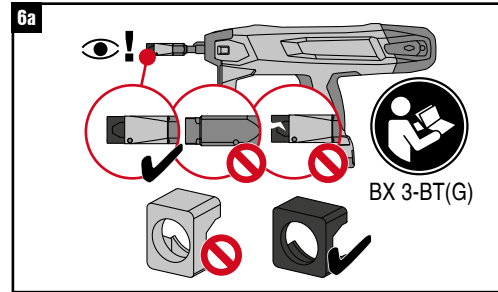
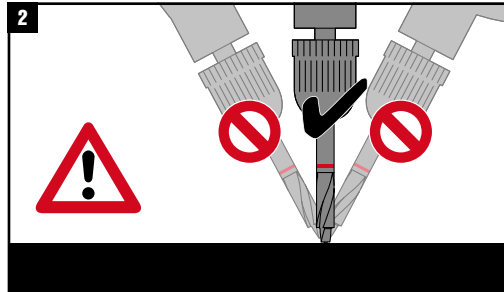

Use with						
X-BT-GR M8/7 SN 8	✓	SF BT 22-A SF BT 18-A	BX 3-BT(G)	X-BT 1/4'' - 20Nm/ 14,8 lb ft	Flange Nut M8	S-NS13 C 95/3 3/4''

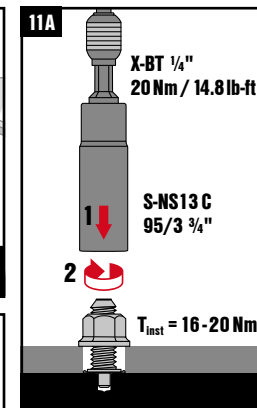
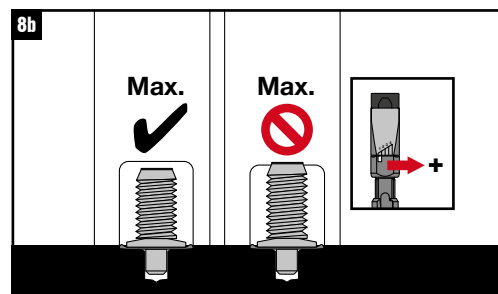
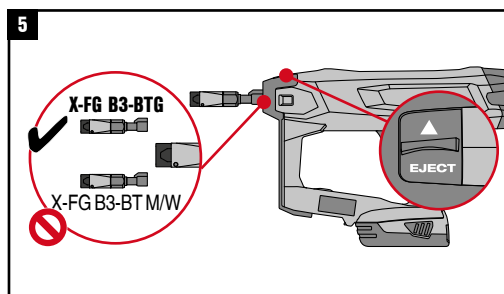
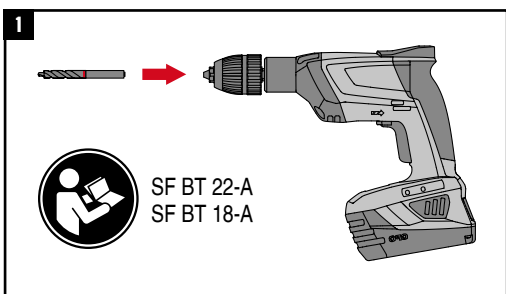
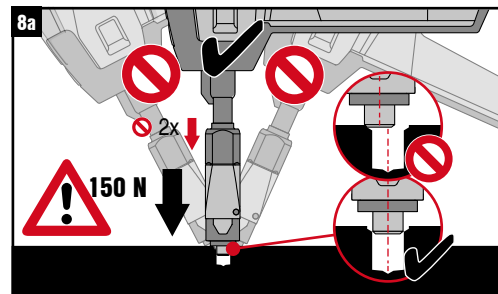
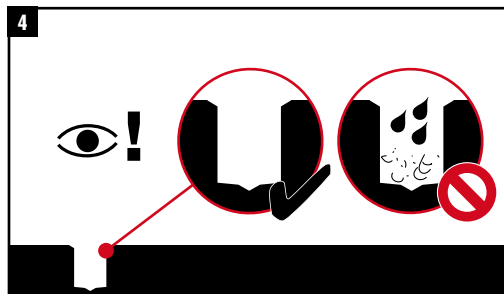

11B

$T_{inst} = 16-20 \text{ Nm}$

SF 14-A	3	13
SF 10W/ 8M-A22	4	11
SFC 14/22-A	2	11
SF 6-A22	1!	1!