

Approval body for construction products
and types of construction

Bautechnisches Prüfamt

An institution established by the Federal and
Laender Governments



European Technical Assessment

ETA-18/0972
of 30 November 2023

English translation prepared by DIBt - Original version in German language

General Part

Technical Assessment Body issuing the
European Technical Assessment:

Deutsches Institut für Bautechnik

Trade name of the construction product

Injection system Hilti HIT-HY 200-A, HIT-HY 200-R,
HIT-HY 200-A V3 and HIT-HY 200-R V3 with HAS-D

Product family
to which the construction product belongs

Bonded fasteners and bonded expansion fasteners for
use in concrete

Manufacturer

Hilti Aktiengesellschaft
Feldkircherstrasse 100
9494 SCHAAN
FÜRSTENTUM LIECHTENSTEIN

Manufacturing plant

Hilti Plants

This European Technical Assessment
contains

21 pages including 3 annexes which form an integral part
of this assessment

This European Technical Assessment is
issued in accordance with Regulation (EU)
No 305/2011, on the basis of

330499-02-0601, Edition 11/2023

This version replaces

ETA-18/0972 issued on 18 July 2023

The European Technical Assessment is issued by the Technical Assessment Body in its official language. Translations of this European Technical Assessment in other languages shall fully correspond to the original issued document and shall be identified as such.

Communication of this European Technical Assessment, including transmission by electronic means, shall be in full. However, partial reproduction may only be made with the written consent of the issuing Technical Assessment Body. Any partial reproduction shall be identified as such.

This European Technical Assessment may be withdrawn by the issuing Technical Assessment Body, in particular pursuant to information by the Commission in accordance with Article 25(3) of Regulation (EU) No 305/2011.

Specific Part

1 Technical description of the product

The Injection systems Hilti HIT-HY 200-A, HIT-HY 200-R, HIT-HY 200-A V3 and HIT-HY 200-R V3 with HAS-D are bonded fasteners consisting of a cartridge with injection mortar Hilti HIT-HY 200-A or Hilti HIT-HY 200-R or Hilti HIT-HY 200-A V3 or Hilti HIT-HY 200-R V3 and the steel element Hilti HAS-D with Hilti sealing washer, a calotte nut and a lock nut in the range of M12, M16 and M20.

The steel element is placed into a drilled hole filled with injection mortar and is anchored via the bond between steel element, injection mortar and concrete.

The product description is given in Annex A.

2 Specification of the intended use in accordance with the applicable European Assessment Document

The performances given in Section 3 are only valid if the anchor is used in compliance with the specifications and conditions given in Annex B.

The verifications and assessment methods on which this European Technical Assessment is based lead to the assumption of a working life of the anchor of at least 50 years. The indications given on the working life cannot be interpreted as a guarantee given by the producer, but are to be regarded only as a means for choosing the right products in relation to the expected economically reasonable working life of the works.

3 Performance of the product and references to the methods used for its assessment

3.1 Mechanical resistance and stability (BWR 1)

Essential characteristic	Performance
Characteristic resistance to static and quasi-static tension load	See Annex B2, C1 and C2
Characteristic resistance to static and quasi-static shear load	See Annex C3
Displacements for static and quasi-static load	See Annex C4
Characteristic resistance for seismic category C1 and C2	No performance assessed

3.2 Safty in Case of fire (BWR 2)

Essential characteristic	Performance
Reaction to fire	Class A1
Resistance to fire	No performance assessed

3.3 Hygiene, health and the environment (BWR 3)

Essential characteristic	Performance
Content, emission and/or release of dangerous substances	No performance assessed

English translation prepared by DIBt

4 Assessment and verification of constancy of performance (AVCP) system applied, with reference to its legal base

In accordance with the European Assessment Document EAD 330499-02-0601 the applicable European legal act is: [96/582/EC].

The system to be applied is: 1

5 Technical details necessary for the implementation of the AVCP system, as provided for in the applicable European Assessment Document

Technical details necessary for the implementation of the AVCP system are laid down in the control plan deposited at Deutsches Institut für Bautechnik.

The following standards and documents are referred to in this European Technical Assessment:

- EN ISO 683-4:2018 Heat-treatable steels, alloy steels and free-cutting steels - Part 4: Free-cutting steels (ISO 683-4:2016)
- EN 206:2013 + A2:2021 Concrete - Specification, performance, production and conformity
- EN 14889-1:2006 Fibres for concrete - Part 1: Steel fibres - Definitions, specifications and conformity
- EN 1992-4:2018 Eurocode 2: Design of concrete structures - Part 4: Design of fastenings for use in concrete
- EOTA TR 055 Design of fastenings based on EAD 330232-00-0601, EAD 330499-00-0601 and EAD 330747-00-0601, February 2018

Issued in Berlin on 30 November 2023 by Deutsches Institut für Bautechnik

Dipl.-Ing. Beatrix Wittstock
Head of Section

beglaubigt:
Stiller

Installed condition

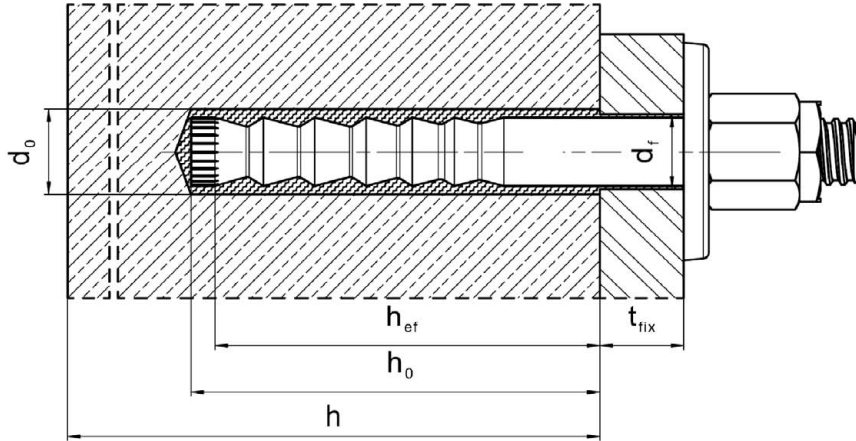

Injection system Hilti HIT-HY 200-A, HIT-HY 200-R, HIT-HY 200-A V3 and
HIT-HY 200-R V3 with HAS-D

Product description
Installed condition

Annex A1

Product description: Injection mortar

Injection mortar Hilti HIT-HY 200-A, Hilti HIT-HY 200-R, Hilti HIT-HY 200-A V3 and Hilti HIT-HY 200-R V3: hybrid system with aggregate, foil pack 330 ml and 500 ml

Marking:
HILTI HIT
HY 200-A
Production time and production line
Expiry date mm/yyyy



Product name: "Hilti HIT-HY 200-A"

Marking:
HILTI HIT
HY 200-R
Production time and production line
Expiry date mm/yyyy



Product name: "Hilti HIT-HY 200-R"

Marking:
HILTI HIT
HY 200-A V3
Production time and production line
Expiry date mm/yyyy



Product name: "Hilti HIT-HY 200-A V3"

Marking:
HILTI HIT
HY 200-R V3
Production time and production line
Expiry date mm/yyyy



Product name: "Hilti HIT-HY 200-R V3"

Static mixer Hilti HIT-RE-M



Injection system Hilti HIT-HY 200-A, HIT-HY 200-R, HIT-HY 200-A V3 and HIT-HY 200-R V3 with HAS-D

Product description
Injection mortar / Static mixer

Annex A2

Fastener: Hilti HAS-D: M12, M16 and M20 with sealing washer

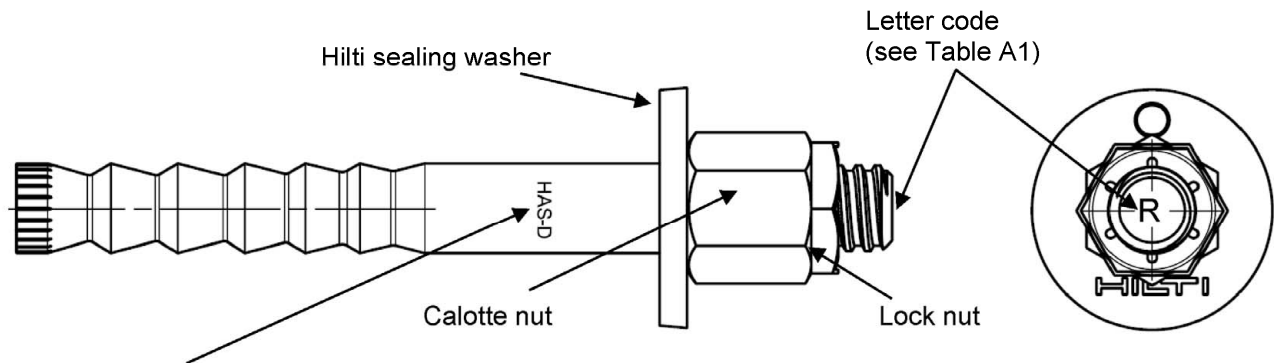

Marking:
HAS-D M..x L Fastener type as well as size and length of anchor rod

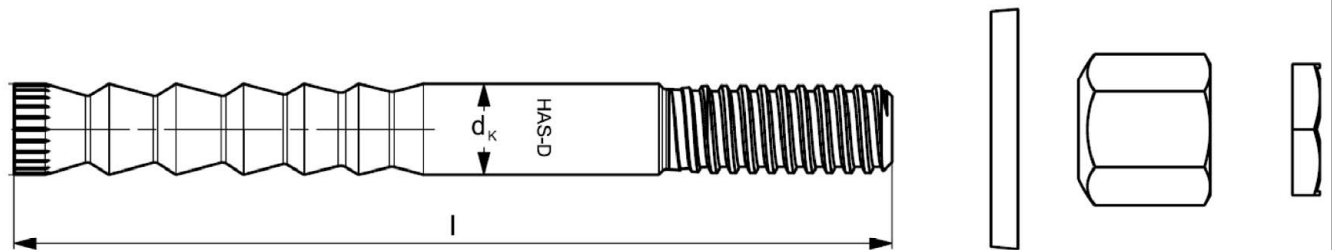

Table A1: Letter code for identification of anchor rod length¹⁾

Letter code		I	J	K	L	M	N	O	P	Q	R
Length of anchor rod l	≥ [mm]	139,7	152,4	165,1	177,8	190,5	203,2	215,9	228,6	241,3	254,0
	< [mm]	152,4	165,1	177,8	190,5	203,2	215,9	228,6	241,3	254,0	279,4

Letter code		S	T	U	V	W	X	Y	Z	>Z
Length of anchor rod l	≥ [mm]	279,4	304,8	330,2	355,6	381,0	406,4	431,8	457,2	482,6
	< [mm]	304,8	330,2	355,6	381,0	406,4	431,8	457,2	482,6	

¹⁾ Anchor length in bold is standard item. For selection of other anchor lengths, check availability of the items.

Table A2: Dimensions

HAS-D...			M12	M16	M20
Shaft diameter	d _k	[mm]	12,5	16,5	22,0
Length of anchor rod l	≥	[mm]	143	180	242
	≤	[mm]	531	565	623
Calotte nut	SW	[mm]	18/19	24	30
Lock nut	SW	[mm]	19	24	30

Injection system Hilti HIT-HY 200-A, HIT-HY 200-R, HIT-HY 200-A V3 and HIT-HY 200-R V3 with HAS-D

Product description
Steel element

Annex A3

Hilti sealing washer to fill the annular gap between anchor and fixture

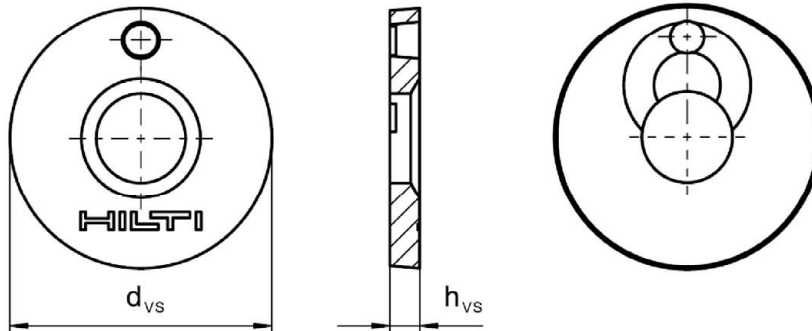

Table A3: Geometry of Hilti sealing washer

Size	M12	M16	M20
Diameter of sealing washer d_{vs} [mm]	44	52	60
Thickness of sealing washer h_{vs} [mm]	5	6	

Injection system Hilti HIT-HY 200-A, HIT-HY 200-R, HIT-HY 200-A V3 and HIT-HY 200-R V3 with HAS-D

Product description
Steel element

Annex A4

Table A4: Materials

Designation	Material
Anchor rod HAS-D	Steel acc. to EN ISO 683-4, galvanized and coated
Sealing washer	Steel, electroplated zinc coated $\geq 5 \mu\text{m}$
Calotte nut	Steel, electroplated zinc coated $\geq 5 \mu\text{m}$
Lock nut	Steel, electroplated zinc coated $\geq 5 \mu\text{m}$

Injection system Hilti HIT-HY 200-A, HIT-HY 200-R, HIT-HY 200-A V3 and
HIT-HY 200-R V3 with HAS-D

Product description
Materials

Annex A5

Specifications of intended use

Anchorage subject to:

- Static and quasi-static loading.

Base material:

- Compacted reinforced or unreinforced normal weight concrete without fibres according to EN 206.
- Strength classes C20/25 to C50/60 according to EN 206.
- Cracked and uncracked concrete.
- The fastener is intended to be used in fibre reinforced concrete according to EN 206 including steel fibres according to EN 14889-1 clause 5, group I. The maximum content of steel fibres is 80 kg/m³.

Temperature in the base material:

- **at installation**
-10 °C to +40 °C for the standard variation of temperature after installation
- **in-service**
Temperature range: -40 °C to +80 °C
(max. long term temperature +50 °C and max. short term temperature +80 °C)

Use conditions (Environmental conditions):

- Structures subject to dry internal conditions.

Design:

- Anchorages are designed under the responsibility of an engineer experienced in anchorages and concrete work.
- Verifiable calculation notes and drawings are prepared taking account of the loads to be anchored. The position of the fastener is indicated on the design drawings (e. g. position of the fastener relative to reinforcement or to supports, etc.).
- Anchorages under static or quasi-static loading are designed in accordance with: EN 1992-4 and EOTA Technical Report TR 055.
- Anchorages in steel fibre reinforced concrete can be designed according to EN 1992-4. The performance for normal weight concrete of strength classes C20/25 to C50/60 without fibres applies.

Installation:

- Concrete condition I1: dry or wet concrete (not in flooded holes) for all drilling techniques.
- Drilling techniques:
 - hammer drilling,
 - hammer drilling with hollow drill bit TE-CD, TE-YD,
 - diamond coring.
- Installation direction D3: downward, horizontal and upward (e.g. overhead) installation.
- Fastener installation carried out by appropriately qualified personnel and under the supervision of the person responsible for technical matters of the site.

Injection system Hilti HIT-HY 200-A, HIT-HY 200-R, HIT-HY 200-A V3 and HIT-HY 200-R V3 with HAS-D

Intended Use
Specifications

Annex B1

Table B1: Installation parameters

HAS-D...			M12	M16	M20
Diameter of fastener	d	[mm]	12	16	20
Nominal diameter of drill bit	d ₀	[mm]	14	18	24
Effective embedment depth	h _{ef}	[mm]	100	125	170
Minimum drill hole depth	h ₀	[mm]	105	133	180
Minimum thickness of concrete member	h _{min}	[mm]	130	160 ¹⁾ / 170	220 ¹⁾ / 230
<u>Pre-setting:</u>					
Maximum diameter of clearance hole in the fixture	d _f	[mm]	14	18	24
<u>Through-setting:</u>					
Maximum diameter of clearance hole in the fixture	d _f	[mm]	16	20	26
Installation torque moment	T _{inst}	[Nm]	30	50	80
Uncracked concrete	Minimum spacing	s _{min,ucr}	80 ²⁾	60	80
	Minimum edge distance	c _{min,ucr}	55 ²⁾	60	80
Cracked concrete	Minimum spacing	s _{min,cr}	50	60	80
	Minimum edge distance	c _{min,cr}	50	60	80

¹⁾ The reverse side of the concrete member shall have no break-through after drilling.

²⁾ For min. edge distance c_{min} ≥ 80 mm, min. spacing s_{min} = 55 mm

Injection system Hilti HIT-HY 200-A, HIT-HY 200-R, HIT-HY 200-A V3 and HIT-HY 200-R V3 with HAS-D

Intended use
Installation parameters

Annex B2

**Table B2: Maximum working time and minimum curing time
HIT-HY 200-A and HIT-HY 200-R**

Temperature in the base material T ¹⁾	HIT-HY 200-A		HIT-HY 200-R	
	Maximum working time t _{work}	Minimum curing time t _{cure}	Maximum working time t _{work}	Minimum curing time t _{cure}
-10 °C to -5 °C	1,5 hours	7 hours	3 hours	20 hours
> -5 °C to 0 °C	50 min	4 hours	2 hours	8 hours
> 0 °C to 5 °C	25 min	2 hours	1 hour	4 hours
>5 °C to 10 °C	15 min	75 min	40 min	2,5 hours
>10 °C to 20 °C	7 min	45 min	15 min	1,5 hours
>20 °C to 30 °C	4 min	30 min	9 min	1 hour
>30 °C to 40 °C	3 min	30 min	6 min	1 hour

¹⁾ The minimum temperature of the foil pack is 0°C.

**Table B3: Maximum working time and minimum curing time
HIT-HY 200-A V3 and HIT-HY 200-R V3**

Temperature in the base material T ¹⁾	HIT-HY 200-A V3		HIT-HY 200-R V3	
	Maximum working time t _{work}	Minimum curing time t _{cure}	Maximum working time t _{work}	Minimum curing time t _{cure}
-10 °C to -5 °C	1,5 hours	7 hours	3 hours	20 hours
> -5 °C to 0 °C	50 min	4 hours	1,5 hours	8 hours
> 0 °C to 5 °C	25 min	2 hours	45 min	4 hours
>5 °C to 10 °C	15 min	75 min	30 min	2,5 hours
>10 °C to 20 °C	7 min	45 min	15 min	1,5 hours
>20 °C to 30 °C	4 min	30 min	9 min	1 hour
>30 °C to 40 °C	3 min	30 min	6 min	1 hour





¹⁾ The minimum temperature of the foil pack is 0°C.

**Injection system Hilti HIT-HY 200-A, HIT-HY 200-R, HIT-HY 200-A V3 and
HIT-HY 200-R V3 with HAS-D**

Intended use
Maximum working time and minimum curing time



Annex B3

Table B4: Parameters of drilling, cleaning and setting tools

Fastener	Drill and clean				Installation
	Hammer drilling		Diamond coring	Brush	Piston plug
HAS-D		Hollow drill bit TE-CD, TE-YD ¹⁾			
					
Size	d ₀ [mm]	d ₀ [mm]	d ₀ [mm]	HIT-RB	HIT-SZ
M12	14	14	14	14	14
M16	18	18	18	18	18
M20	24	24	24	24	24

¹⁾ With vacuum cleaner Hilti VC 10/20/40 (automatic filter cleaning activated, eco mode off) or a vacuum cleaner providing equivalent cleaning performance in combination with the specified Hilti hollow drill bit TE-CD or TE-YD.

Table B5: Cleaning alternatives

<p>Compressed Air Cleaning (CAC): Air nozzle with an orifice opening of minimum 3,5 mm in diameter.</p>	
<p>Automatic Cleaning (AC): Cleaning is performed during drilling with Hilti TE-CD and TE-YD drilling system including vacuum cleaner.</p>	

Injection system Hilti HIT-HY 200-A, HIT-HY 200-R, HIT-HY 200-A V3 and HIT-HY 200-R V3 with HAS-D

Intended use
Drilling, cleaning and setting tools

Annex B4

Installation instruction

Hole drilling

a) Hammer drilling

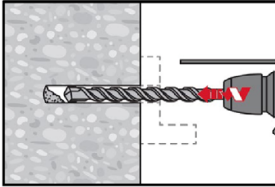

Through-setting: Drill hole through the clearance hole in the fixture to the required drilling depth with a hammer drill set in rotation-hammer mode using an appropriately sized carbide drill bit.

Pre-setting: Drill hole to the required drilling depth with a hammer drill set in rotation-hammer mode using an appropriately sized carbide drill bit.

b) Hammer drilling with Hilti hollow drill bit (AC)

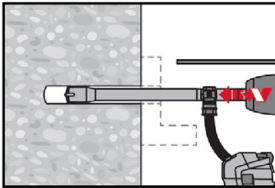

Pre- / Through-setting: Drill hole to the required embedment depth with an appropriately sized Hilti TE-CD or TE-YD hollow drill bit with vacuum attachment following the requirements given in Table B4. This drilling system removes the dust and cleans the drill hole during drilling when used in accordance with the user's manual. After drilling is completed, proceed to the "injection preparation" step in the installation instruction.

c) Diamond coring

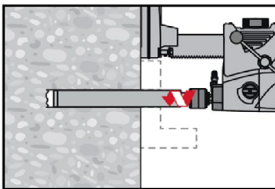

Diamond coring is permissible when suitable diamond core drilling machines and corresponding core bits are used.

Through-setting: Drill hole through the clearance hole in the fixture to the required drilling depth.

Pre-setting: Drill hole to the required embedment depth.

Drill hole cleaning: just before setting the fastener, the drill hole must be free of dust and debris.

a) Compressed Air Cleaning (CAC): for all drill hole diameters d_0 and all drill hole depths h_0 .

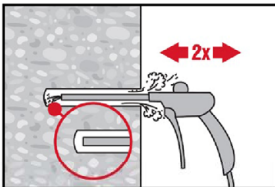

Blow 2 times from the back of the hole (if needed with nozzle extension) over the whole length with oil-free compressed air (min. 6 bar at 6 m³/h) until return air stream is free of noticeable dust.

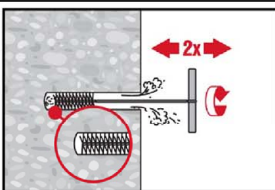

Brush 2 times with the specified brush (see Table B4) by inserting the steel brush Hilti HIT-RB to the back of the hole (if needed with extension) in a twisting motion and removing it.

The brush must produce natural resistance as it enters the drill hole (brush $\varnothing \geq$ drill hole \varnothing) - if not the brush is too small and must be replaced with the proper brush diameter.

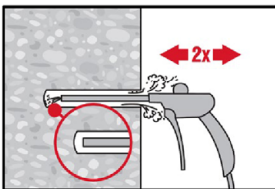

Blow again with compressed air 2 times until return air stream is free of noticeable dust.

Injection system Hilti HIT-HY 200-A, HIT-HY 200-R, HIT-HY 200-A V3 and HIT-HY 200-R V3 with HAS-D

Intended use
Installation instructions

Annex B5

b) Cleaning of diamond cored holes: for all drill hole diameters d_0 and all drill hole depths h_0 .

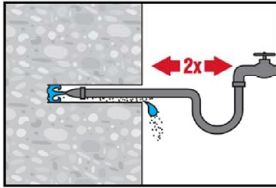

Flush 2 times by inserting a water hose (water-line pressure) to the back of the hole until water runs clear.

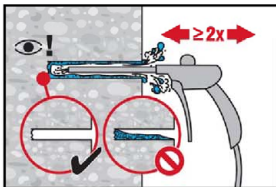

Blow 2 times from the back of the hole (if needed with nozzle extension) with oil-free compressed air (min. 6 bar at 6 m³/h) until return air stream is free of noticeable dust and water.

Injection preparation

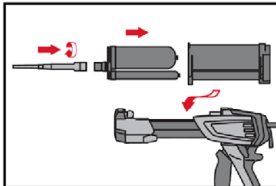

Tightly attach Hilti mixing nozzle HIT-RE-M to foil pack manifold. Do not modify the mixing nozzle.
Observe the instruction for use of the dispenser.
Check foil pack holder for proper function. Insert foil pack into foil pack holder and put holder into dispenser.

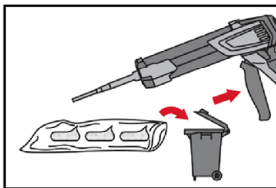

The foil pack opens automatically as dispensing is initiated. Depending on the size of the foil pack an initial amount of adhesive must be discarded. Discarded quantities are:

2 strokes	for 330 ml foil pack,
3 strokes	for 500 ml foil pack
4 strokes	for 500 ml foil pack ≤ 5°C.

The minimum temperature of the foil pack is 0°C.

Inject adhesive from the back of the drill hole without forming air voids (through- and pre-setting)

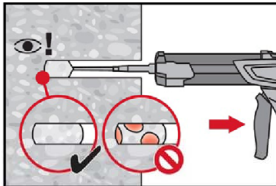

Inject the adhesive starting at the back of the hole, slowly withdrawing the mixer with each trigger pull. The quantity of mortar should be selected so that the annular gap in the borehole is filled.

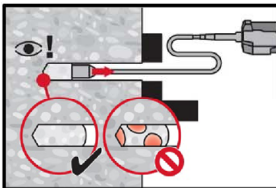

Injection is possible with the aid of extensions and piston plugs. Assemble HIT-RE-M mixer, extension(s) and appropriately sized piston plug (see Table B4). Insert piston plug to back of the hole and inject adhesive. During injection the piston plug will be naturally extruded out of the drill hole by the adhesive pressure. The quantity of mortar should be selected so that the annular gap in the borehole is filled.

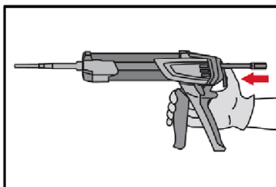

After injection is completed, depressurize the dispenser by pressing the release trigger. This will prevent further adhesive discharge from the mixer.

Injection system Hilti HIT-HY 200-A, HIT-HY 200-R, HIT-HY 200-A V3 and HIT-HY 200-R V3 with HAS-D

Intended use
Installation instructions

Annex B6

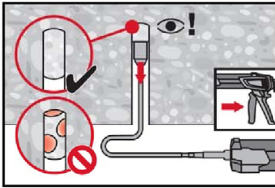

For overhead installation, the injection is only possible with the aid of extensions and piston plugs. Assemble HIT-RE-M mixer, extension(s) and appropriately sized piston plug (see Table B4). Insert piston plug to back of the hole and inject adhesive. During injection, the piston plug will be naturally extruded out of the drill hole by the adhesive pressure.

Setting the fastener

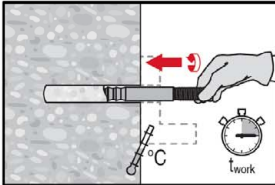

Before use, verify that the fastener is dry and free of oil and other contaminants. Set the fastener to the required embedment depth before working time t_{work} (see Table B2 and B3) has elapsed.

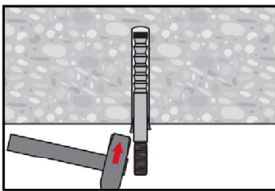

For overhead installation fix embedded parts with e.g. wedges.

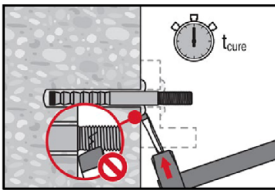

After required curing time t_{cure} (see Table B2 and B3) remove excess mortar.

Setting the fastener with clearance between concrete and anchor plate (only if the fastener is loaded in axial direction)

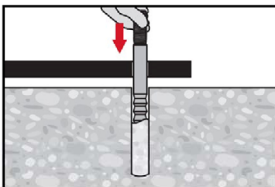

Set the fastener to the required embedment depth before working time t_{work} (see Table B2 and B3) has elapsed.

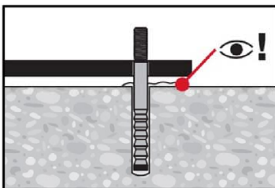

Check if mortar excess from the borehole. The annular gap in the fixture does not have to be filled.

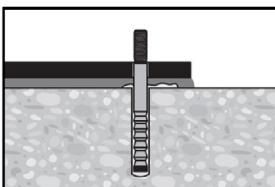

After required curing time t_{cure} (see Table B2 and B3) backfill the anchor plate.

Injection system Hilti HIT-HY 200-A, HIT-HY 200-R, HIT-HY 200-A V3 and HIT-HY 200-R V3 with HAS-D

Intended use
Installation instructions

Annex B7

Final assembly with sealing washer

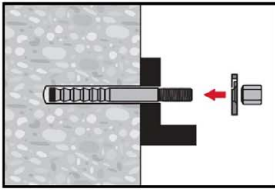

Orient round part of the calotte nut to the sealing washer and install.

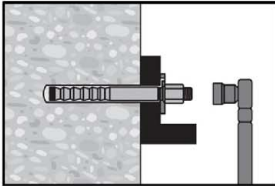

The required installation torque moment is given in Table B1.

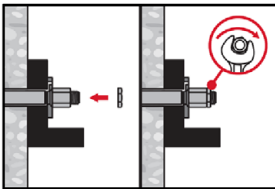

Apply the lock nut and tighten with a $\frac{1}{4}$ to $\frac{1}{2}$ turn.

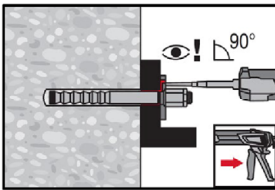

Fill the annular gap between the anchor rod and fixture completely with Hilti injection mortar HIT-HY 200 or HIT-HY 200 V3. The static mixer nozzle must be put orthogonally on the filling hole. After required curing time t_{cure} (see Table B2 and B3), the fastener can be loaded.

Injection system Hilti HIT-HY 200-A, HIT-HY 200-R, HIT-HY 200-A V3 and HIT-HY 200-R V3 with HAS-D

Intended use
Installation instructions

Annex B8

Table C1: Essential characteristics under tension load in concrete

HAS-D...			M12	M16	M20	
Effective embedment depth	h_{ef}	[mm]	100	125	170	
Installation safety factor	γ_{inst}	[-]	1,0			
Steel failure						
Characteristic resistance	$N_{Rk,s}$	[kN]	57	111	188	
Partial factor	$\gamma_{Ms,N}^{1)}$	[-]	1,5			
Pull-out failure						
Characteristic bond resistance in uncracked concrete C20/25						
Temperature range: 50 °C / 80 °C	$N_{Rk,p,ucr}$	[kN]	49,2	68,8	109	
Characteristic bond resistance in cracked concrete C20/25						
Temperature range: 50 °C / 80 °C	$N_{Rk,p,cr}$	[kN]	34,4	48,1	76,3	
Factor for the influence of concrete strength class $N_{Rk,p} = N_{Rk,p,(C20/25)} \cdot \psi_c$	ψ_c	C30/37	1,22			
		C40/50	1,41			
		C50/60	1,58			
Concrete cone failure						
Factor for uncracked concrete	$k_{ucr,N}$	[-]	11,0			
Factor for cracked concrete	$k_{cr,N}$	[-]	7,7			
Edge distance	$c_{cr,N}$	[mm]	$1,5 \cdot h_{ef}$			
Spacing	$s_{cr,N}$	[mm]	$3,0 \cdot h_{ef}$			
Splitting failure for standard thickness of concrete member						
Standard thickness of concrete member		h	[mm]	200	250	340
Case 1	Edge distance	$c_{cr,sp}$	[mm]	$1,5 \cdot h_{ef}$		
	Spacing	$s_{cr,sp}$	[mm]	$2,0 \cdot c_{cr,sp}$		
	Characteristic resistance in uncracked concrete C20/25	$N_{Rk,sp}^0$	[kN]	40	50	109
Case 2	Edge distance	$c_{cr,sp}$	[mm]	$2,0 \cdot h_{ef}$		$1,5 \cdot h_{ef}$
	Spacing	$s_{cr,sp}$	[mm]	$2,0 \cdot c_{cr,sp}$		
	Characteristic resistance in uncracked concrete C20/25	$N_{Rk,sp}^0$	[kN]	49,2	68,8	109

Injection system Hilti HIT-HY 200-A, HIT-HY 200-R, HIT-HY 200-A V3 and HIT-HY 200-R V3 with HAS-D

Performances
Essential characteristics under tension load in concrete

Annex C1

Table C1 continued

Splitting failure for minimum thickness of concrete member						
Minimum thickness of concrete member		h_{\min}	[mm]	130	160	220
Case 1	Edge distance	$c_{cr,sp}$	[mm]	$1,5 \cdot h_{ef}$		
	Spacing	$s_{cr,sp}$	[mm]	$2,0 \cdot c_{cr,sp}$		
	Characteristic resistance in uncracked concrete C20/25	$N^0_{Rk,sp}$	[kN]	30	40	75
Case 2	Edge distance	$c_{cr,sp}$	[mm]	$3,0 \cdot h_{ef}$		$2,6 \cdot h_{ef}$
	Spacing	$s_{cr,sp}$	[mm]	$2,0 \cdot c_{cr,sp}$		
	Characteristic resistance in uncracked concrete C20/25	$N^0_{Rk,sp}$	[kN]	49,2	68,8	109

¹⁾ In absence of national regulations.

Injection system Hilti HIT-HY 200-A, HIT-HY 200-R, HIT-HY 200-A V3 and HIT-HY 200-R V3 with HAS-D

Performances
Essential characteristics under tension load in concrete

Annex C2

Table C2: Essential characteristics under shear load in concrete

HAS-D...			M12	M16	M20
Installation factor	γ_{inst}	[-]	1,0		
Steel failure without lever arm					
Characteristic resistance	$V^0_{Rk,s}$	[kN]	34	63	149
Partial factor	$\gamma_{Ms,V}$	¹⁾ [-]	1,25		
Ductility factor	k_7		1,0		
Steel failure with lever arm					
Characteristic resistance	$M^0_{Rk,s}$	[Nm]	105	266	519
Partial factor	$\gamma_{Ms,V}$	¹⁾ [-]	1,25		
Concrete pry-out failure					
Pry-out factor	k_8	[-]	2,0		
Concrete edge failure					
Effective length of fastener	l_f	[mm]	100	125	170
Outside diameter of fastener	d_{nom}	[mm]	14	18	24
Partial factor	γ_{Mc}	¹⁾ [-]	1,5		

¹⁾ In absence of national regulations.

Injection system Hilti HIT-HY 200-A, HIT-HY 200-R, HIT-HY 200-A V3 and HIT-HY 200-R V3 with HAS-D

Performances
Essential characteristics under shear load in concrete

Annex C3

Table C3: Displacements under tension load in concrete¹⁾

HAS-D...		M12	M16	M20
Uncracked concrete				
Displacement	δ_{N0} -Factor [mm/kN]	0,017	0,018	0,011
Displacement	$\delta_{N\infty}$ -Factor [mm/kN]	0,054	0,039	0,024
Cracked concrete				
Displacement	δ_{N0} -Factor [mm/kN]	0,035	0,029	0,021
Displacement	$\delta_{N\infty}$ -Factor [mm/kN]	0,076	0,054	0,034

¹⁾ Calculation of the displacement:

$$\delta_{N0} = \delta_{N0}\text{-Faktor} \cdot N; \quad \delta_{N\infty} = \delta_{N\infty}\text{-Faktor} \cdot N; \quad (N: \text{applied tension force}).$$

Table C4: Displacements under shear load in concrete¹⁾

HAS-D...		M12	M16	M20
Displacement	δ_{V0} -Factor [mm/kN]	0,17	0,11	0,057
Displacement	$\delta_{V\infty}$ -Factor [mm/kN]	0,26	0,16	0,087

¹⁾ Calculation of the displacement:

$$\delta_{V0} = \delta_{V0}\text{-factor} \cdot V; \quad \delta_{V\infty} = \delta_{V\infty}\text{-factor} \cdot V; \quad (V: \text{applied shear force}).$$

Injection system Hilti HIT-HY 200-A, HIT-HY 200-R, HIT-HY 200-A V3 and HIT-HY 200-R V3 with HAS-D

Performances
Displacements under tension and shear load in concrete

Annex C4