

DECLARATION OF PERFORMANCE

according to Annex III of the Regulation (EU) Nr. 305/2011 (Construction Products Regulation)

Hilti Firestop Cable Collar

No. "Hilti CFS-RCC"

1. Unique identification code of the product-type:

Hilti CFS-RCC

2. Intended use:

Fire Stopping and Sealing Product for Penetration Seals, see ETA-16/0382 (24.08.2016)

Cable penetrations	Cables, Cable bundles, Cable trays, Conduits	The field of application has to comply with the content of the ETA-16/0382
Pipe penetrations	Combustible and Non-combustible pipes	
Mixed penetrations		

3. Manufacturer:

HILTI Corporation, Feldkircherstrasse 100, 9494 Schaan, Principality of Liechtenstein

4. System of AVCP:

System 1

5. European Assessment Document:

ETAG No. 026-1 and ETAG No. 026-2

European Technical Assessment:

ETA-16/0382 (24.08.2016)

Technical Assessment Body:

UL International (UK) Limited, Nr. 0843

Notified body/s:

UL International (UK) Limited, Nr. 0843

6. Declared performance:

Essential characteristic	Declared performance / Harmonised technical specification
Reaction to fire	Class E according to EN 13501-1
Resistance to fire	Resistance to fire performance and field of application in accordance with EN 13501-2. See Annex
Air permeability	Tested according to EN 1026:2000: 0.023m ³ /(hm ²)@50Pa, 1.91m ³ /(hm ²)@250Pa, 4.44m ³ /(hm ²)@600Pa
Release of Dangerous Substances	No dangerous substances. Use categories: IA1, S/W3
Airborne Sound Insulation	Tested according to EN ISO 717-1 Rw (C; Ctr) = 63 (-3;-9) dB – with and without cable
Thermal Properties	Tested according to EN 12667: Lambda = 0.089W/mK; R = 0.55m ² K/W
Durability and Serviceability	Z ₂ according ETAG 026-2
Other	Not applicable / No performance determined

The performance of the product identified above is in conformity with the set of declared performances. This declaration of performance is issued in accordance with Regulation (EU) No 305/2011, under the sole responsibility of the manufacturer identified above.

Signed for and on behalf of the manufacturer by:



Martin Althof
Head of Quality
Business Unit Chemicals
Hilti Corporation

Schaan, August 2016

A.1 General information

A.1.1 Wall/floor constructions

Flexible wall

The wall must have a minimum thickness of 100 mm and comprise timber or steel studs lined on both faces with minimum 2 layers of 12,5 mm thick boards according EN 520 type F.

For timber stud walls there must be a minimum distance of 100 mm of the seal to any stud and the cavity between stud and seal must be closed and a minimum of 100 mm insulation of Class A1 or A2 (in accordance with EN 13501-1) in the cavity between stud and seal is necessary.

Rigid wall:

The wall must have a minimum thickness of 100 mm and comprise concrete, aerated concrete or masonry, with a minimum density of 550 kg/m³.

Rigid floor:

The floor must have a minimum thickness of 150 mm and comprise aerated concrete or concrete with a minimum density of 550 kg/m³.

The walls / floors must be classified in accordance with EN 13501-2 for the required fire resistance period or fulfil the requirements of the relevant Eurocode.

A.1.2 Seal types

There are several seal types:

- Both sides
- Both sides + foam inlay
- Single sided wall
- Single sided floor

A.1.2.1 Seal type – Both sides

The penetration seal depth is approximately 260/310mm (t_A) comprised by a wall/floor of at least 100/150 mm (t_E) and two times the thickness of the Hilti Cable Collar (A), as displayed in (see Figure 1)

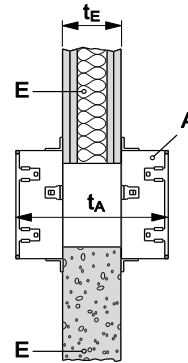

Figure 1: both sides

Aperture framing is not necessary.

In some cases for cables a Hilti Firestop Putty Bandage CFS-P BA (see Figure 1a / 1b) or increasing the t_E for higher ratings is required.

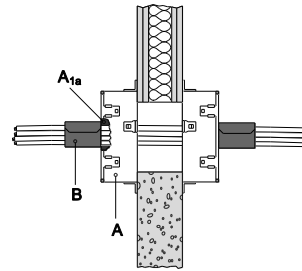

Figure 1a: CFS-P BA wall

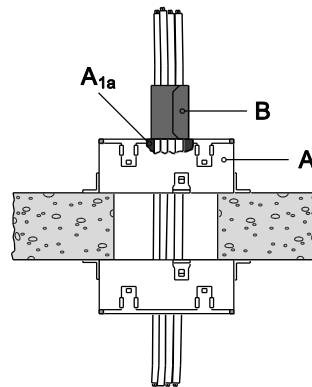

Figure 1b: CFS-P BA floor

A.1.2.2 Seal type – Both sides + foam inlay

The penetration seal depth is approximately 260/310mm comprised by a wall/floor of at least 100/150 mm and two times the thickness of the Hilti Cable Collar (A) where all visible PU inlay (till the corner profile of the metal housing) is replaced by another foam (type: Hilti Firestop Foam CFS-F FX . (Figure 2)

Aperture framing is not necessary.

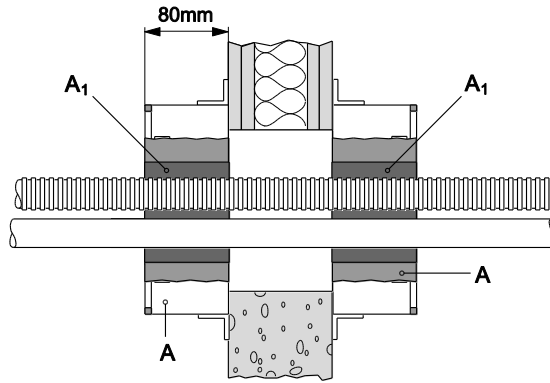

Figure 2: Seal type - Both sides + foam inlay

A.1.2.3 Seal type – Single sided wall

For single sided applications a frame made from gypsum board (E_1) may be fixed to the wall around the opening to increase the thickness of building element (t_E) to ≥ 150 mm. The penetration seal depth is approximately 230 mm (t_A), as shown in Figure 3.

The frame (E_1) must cover a width (w_A) ≥ 100 mm and must be fixed with metal screws (Figure 4).

The opening has to be filled out completely with Hilti Firestop Foam CFS-F FX or (A_1) for wall applications.

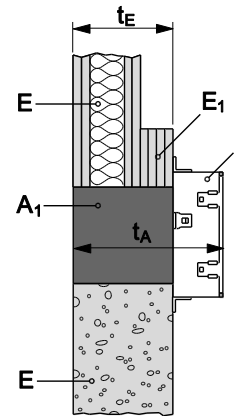

Figure 3: Seal type - Single sided

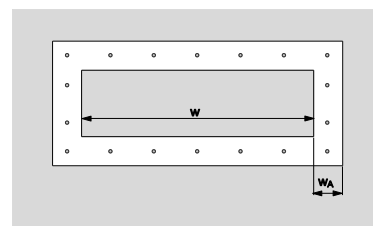

Figure 4: Gypsum frame - Front view

A.1.2.4 Seal type – Single sided floor

For floor applications the annular space between services and floor edges (E) has to be filled out with normal gypsums and lime or cement-based mortars(M) with a compressive strength equal to or lower than 10 N/mm² (M1-M10 mortar according to DIN EN 980, e.g. HILTI CP 633), as displayed in Figure 5.

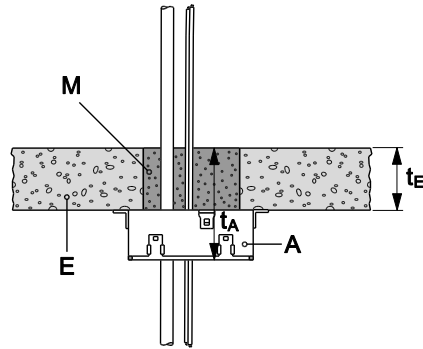

Figure 5: Seal type - Single sided for floor applications

Gaps between services and Hilti Firestop Cable Collar (A) are filled with Hilti Firestop Filler CFS-FIL, depth 20 mm.

Seal thickness (t_A) is about 230 mm (t_E 150 + 80 mm

In some cases a t_E from 200mm is required to achieve a higher rating (see A.2).

A.1.3 Filling of gaps in penetrations seal

Gaps between services and Hilti Firestop Cable Collar are filled with Hilti Firestop Filler CFS-FIL (A_{1a}), depth 20 mm, as shown in Figure 6.

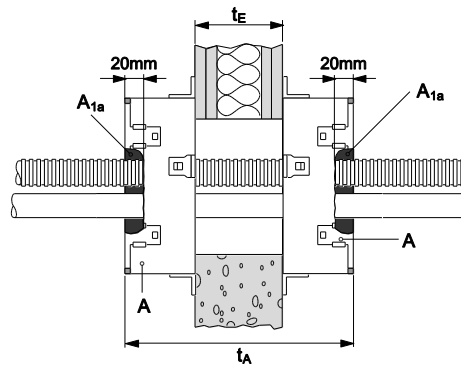

Figure 6: Penetrating sealing

A.1.4 Housing concepts and maximum dimensions

The products Hilti Firestop Cable Collar CFS-RCC and Hilti Firestop Cable Collar Extension CFS-RCC Ext can be combined as single, double or triple application. The installer can combine up to three inlays in a horizontal or vertical manner. (see Figure 7)

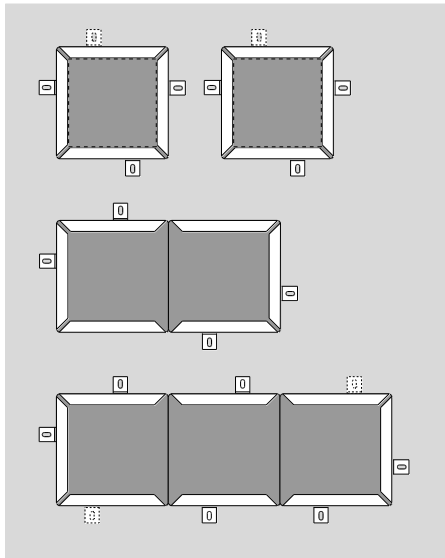

Figure 7: Basic configuration of the CFS-RCC

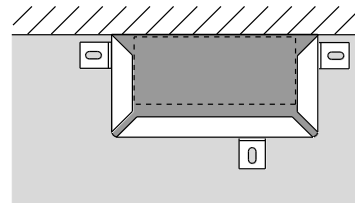

Figure 8: Side configuration of the CFS-RCC

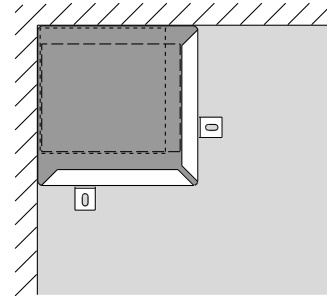

Figure 9: Corner configuration of the CFS-RCC

The inlay can also be cut in half and the housing adjusted in size accordingly.

Figure 8 highlights this application for a single application. Up to three inlays can be combined in this configuration.

The inlay can be installed in corner applications. Enclosing walls or floors can make two housing sides redundant as shown in Figure 9

The maximum seal and opening sizes are given below.

Maximum dimensions [mm x mm]	Basic configuration	Corner configuration	Side configuration
Seal	600 x 200	600 x 200	600 x 200
Opening [$W_1 \times W_1$]	562 x 162	581 x 181	581 x 162

Cable collar inlay has to be cut to fit to penetrating services.

A boundary stripe of minimum 19mm inlay has to be left to each free edge of collar.

The total cross section of the cables (including cable supporting systems like cable trays etc.) must not be more than 60% of the total seal size. In the single application the area $W_1 \times W_1$ corresponds to 60% of the total seal size and can be 100% filled with cables.

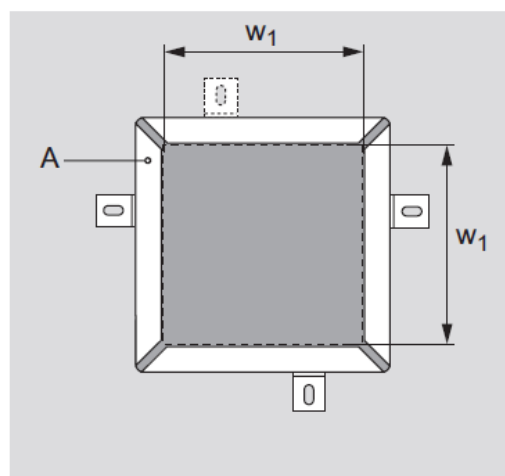

Single application with maximum opening size

A.1.5 Angle of penetrating services

Cables must be perpendicular to the seal surface.
Cables of size $\varnothing \leq 21$ mm additionally can be phased out
In a 90° bend manner parallel to the wall / floor surface.
(Figure 10)

In this case up to 2 metal segments can be taken out
to open space for cable penetration.

Three fixing hooks have to be used for fixation of collar

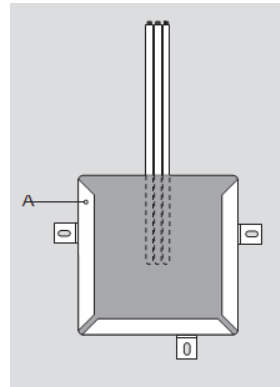

Figure 10: Bended cables

A.1.6 Cluster Arrangement and distances

Minimum distances (see Figure 11):

$S_a = 60$ mm (horizontal distance between cable collars
linear)

$S_b = 60$ mm (vertical distance between cable collars in
cluster arrangement)

Note:

When S_a and S_b are at least 60mm, the distance
between openings is 100mm.

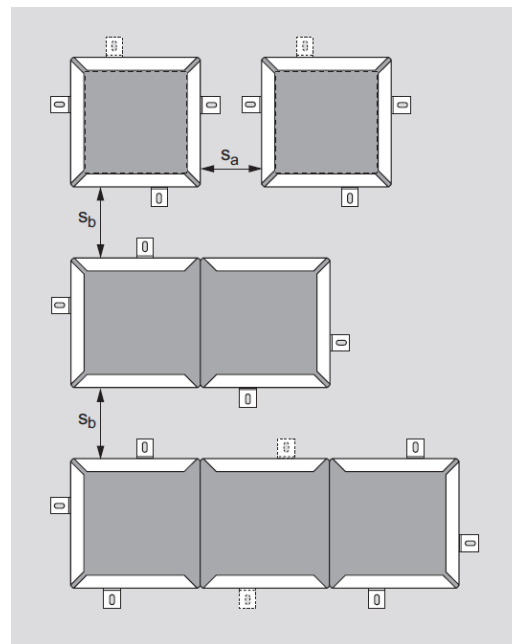

Figure 11: Cluster arrangement

A.1.7 Application with existing firestop or renovation:

A.1.7.1 Hilti CFS-RCC double sided

Old materials (A', e.g. unknown material, paper, boards, foams, intumescent products, sleeved opening/cladding tubes...) are allowed to remain inside the wall or floor opening in between two Hilti Cable Collars (A). These have no negative influence of the fire resistance performance of the collar system. The application is illustrated in Figure 12.

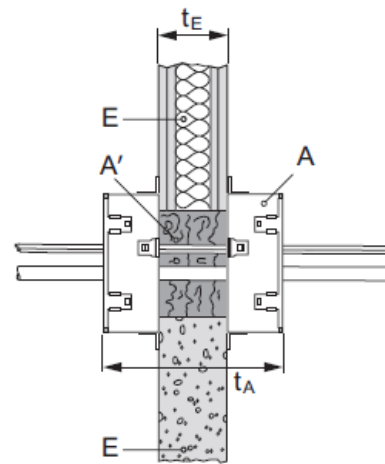

Figure 12: Application with old materials in the seal

A.1.7.2 Hilti CFS-RCC single sided wall

The single sided application of the Hilti Cable Collar requires Hilti Firestop foam CFS-F FX or CP 660 in the opening. (A1.2.3.) (see Figure 3)

A.1.7.3 Hilti CFS-RCC single sided floor

The single sided application of the Hilti Cable Collar requires mortar (see Figure 5) in the opening. (A1.2.4)

A.1.8 Penetrating services

A.1.8.1 Foamed elastomeric insulation – combustible insulation

Foamed elastomeric insulations include the following brand names:

Armstrong Armaflex AF, Armstrong Armaflex SH, Armstrong Armaflex Ultima, Armstrong Armaflex HT, nmc Insul-Tube normal quality, nmc Insul-Tube H-Plus, Kaimann Kaiflex KK, Kaimann Kaiflex KK-Plus, L'isolante k-Flex H, L'isolante k-Flex HT, L'isolante k-Flex ECO, L'isolante k-Flex ST, L'isolante k-Flex ST-Plus

A.1.8.2 Mineral wool insulation – non combustible insulation

Mineralwool pipe insulation, (w/wo aluminium foil faced) has to be with an melting point $\geq 1000^{\circ}\text{C}$, with an reaction to fire class (min.) A2_L-s1, d0 acc. EN 13501-1.

A.1.8.3 Cables

<u>Penetrating services</u>	<u>Description</u>
Small cables:	All cable types currently and commonly used in building practice in Europe (e.g. power, control, signal, telecommunication, data, optical fibre cables, with or without cable supports) with a diameter $\varnothing \leq 21$ mm .
Medium and large cables:	All cable types currently and commonly used in building practice in Europe (e.g. power, control, signal, telecommunication, data, optical fibre cables, with or without cable supports) with a diameter $21 \leq \varnothing \leq 80$ mm .
Cable bundle:	Tied cable bundle with a diameter $\varnothing \leq 150$ mm consisting of small cables with a diameter $\varnothing \leq 21$ mm. For tied cable bundles the space between the cables needs not be sealed.
Cable support construction:	Perforated, non-perforated metal cable trays and cable steel ladders with a melting point higher than 1100°C (e.g. galvanised steel, stainless steel). Trays with organic coatings are covered if their overall classification is minimum A2 according to EN 13501-1.
Non sheathed cables:	All cables are classified with and without cable support construction. Non sheathed cables (wires) with a diameter $\varnothing \leq 24$ mm .
Waveguides:	Waveguides (coaxial): $27,8 \text{ mm} \leq \varnothing \leq 59,9 \text{ mm}$ RFS Cellflex LCF 78-50 JA $\varnothing 27,8 \text{ mm}$ RFS Cellflex LCF 214-50 J $\varnothing 59,9 \text{ mm}$ RFS Heliflex HCA 78-50 JFNA $\varnothing 28,0 \text{ mm}$ RFS Radialflex RLKW 78-50 $\varnothing 28,5 \text{ mm}$ RFS Radialflex RLKU 158-50 JFLA $\varnothing 48,2 \text{ mm}$

A.1.8.4 Conduits

Penetrating services

Description

Single conduits $\varnothing \leq 16$ mm:	Rigid, flexible and pliable plastic conduits and metal conduits with a diameter $\varnothing \leq 16$ mm with or without cables
Single conduits $\varnothing \leq 50$ mm:	Rigid, flexible and pliable plastic conduits with a diameter $\varnothing \leq 50$ mm with or without cables
Conduit bundle:	Bundle with a diameter $\varnothing \leq 80$ mm of rigid, flexible and pliable plastic conduits with a max. diameter $\varnothing \leq 50$ mm with or without cables

A.1.8.5 Special penetration bundle e.g. Clima splitt

Penetrating service is a bundle (distance between C1/C2/C3 ≥ 0 mm) consisting of 2 cables (C₁), 1 condensate pipe (C₂) and 2 copper pipes (C₃) with combustible insulation as shown in Figure 13.

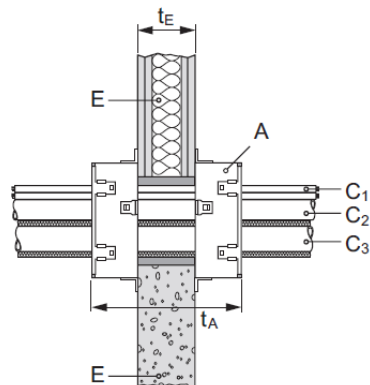

Figure 13: e.g. Climasplit system

Bundle can be applied with a distance ≥ 0 mm to the seal of edge (S₁) and a distance ≥ 0 mm between all the services (C1/C2/C3) (Figure 13a)

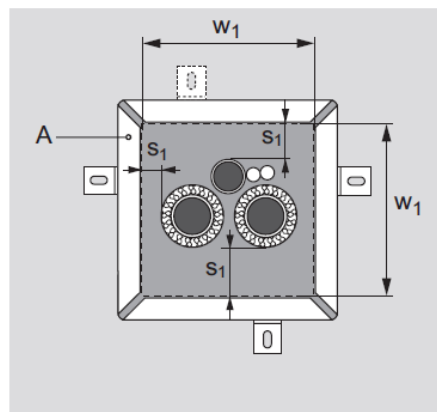

Figure 13a: distance between C1 / C2 / C3

A.1.8.5.1 Bundle with foamed elastomeric insulation – (combustible insulation)

Copper pipe (C ₃) (C/U) with 9mm foamed elastomeric –insulation e.g. AF 1		Condensate Pipe (C ₂) (U/U) (PVC, PE, fabric tube...) Ø mm x wall thickness	Cables (C ₁)	
Pipe 1 Ø mm x wall thickness	Pipe 2 Ø mm x wall thickness		Cable 1 mm ²	Cable 2 mm ²
42x 1,2 35x1,2 28x1,0 18x1,0 12x0,8 8x0,8 6x0,8	28x1,0 18x1,0 12x0,8 8x0,8 6x0,8	40x2,0 32x2,0 25x2,0 20x2,0	5x6 5x1,5	5x6 5x1,5
35x1,2	35x1,2			

A.1.8.5.2 Bundle with PE / PEF insulation – (combustible insulation)

Copper pipe (C ₃) (C/U) with 9mm PE / PEF –insulation e.g. pre insulated pipes (WicuFlex or SangiTwin)		Condensate Pipe (C ₂) (U/U) (PVC, PE, fabric tube...) Ø mm x wall thickness	Cables (C ₁)	
Pipe 1 Ø mm x wall thickness	Pipe 2 Ø mm x wall thickness		Cable 1 mm ²	Cable 2 mm ²
22x1,0 19x1,0 18x1,0 12x0,8 8x0,8 6x0,8	22x1,0 12,7x0,8 18x1,0 12x0,8 8x0,8 6x0,8	32x2,0 25x2,0 20x2,0	5x6 5x1,5	5x6 5x1,5

A.1.8.6 Pipes

A.1.8.6.1 Combustible pipes (non insulated)

Type	Pipe Ø ≤ [mm]	Wall thickness [mm]	Condition
PVC pipes (EN 1451-1 / 1452-2)	50	1,8 ≤ t ≤ 3,7	U/U
PE pipes (EN ISO 15494)/ ABS (1455-1)/ SAN+PVC (EN 1565-1)	50	1,8 ≤ t ≤ 4,6	U/U
PP pipes (EN1451)	50	1,8 ≤ t ≤ 3,0	U/U
PP pipes (other/no standard)	50	1,8 ≤ t ≤ 2,0	U/U

PP pipes other / non-standard include the following brand names:

Friatec db bluue, Rehau Raupiano, Poloplast Polokal NG, Wavin SiTec, Geberit Silent PP, Coes Blue Power, Coes PhoNoFire, Valsir Triplus, Pipelive Master 3, Marely Silent, Mainpex Mainpower, Poloplast Polokal 3S, Ostendorf Slolan db, Valsir Silere Wavin AS.

A.1.8.6.2 Copper pipes insulated

Insulation Type	Pipe Ø [mm]	Wall thickness [mm]	Pipe insul. thickness [mm]	Total pipe insul. length [mm] LS	Condition
foamed elastomeric insulation	12-28	$1,0 \leq t \leq 14,2$	7,5 – 35,0 e.g. AF1 – AF6	≥ 800	C/U
	28-42	$1,0 \leq t \leq 14,2$	13,5 – 36,5 e.g. AF2 – AF6	≥ 800	C/U
mineral wool insulation	12-28	$1,0 \leq t \leq 14,2$	20 e.g. Rockwool RS 800	≥ 800	C/U
	28-42	$1,0 \leq t \leq 14,2$	40 e.g. Rockwool RS 800	≥ 1000	C/U

A.1.8.6.3 **Steel pipes (insulated)**

Insulation Type	Pipe Ø [mm]	Wall thickness [mm]	Pipe insul. thickness [mm]	Total pipe insul. length [mm] LS	Condition
foamed elastomeric insulation	40-108	$1,2 \leq t \leq 14,2$	13,5 – 23,0 e.g. AF2 – AF4	≥ 1100	C/U
	108-114	$2,0 \leq t \leq 14,2$	14,5 – 23,5 e.g. AF2 – AF4	≥ 1100	C/U
mineral wool insulation	12-108	$1,2 \leq t \leq 14,2$	20 e.g. Rockwool RS 800	≥ 1000	C/U
	108-114	$2,0 \leq t \leq 14,2$	20 e.g. Rockwool RS 800	≥ 1000	C/U

A.1.8.6.4 **Aluminum composite pipes with foamed elastomeric insulation**

Type	Pipe Ø [mm]	Wall thickness [mm]	Pipe insulation thick. [mm]	Total pipe insul. (symmetric) length [mm] LS	Cond.
Aluminium composite pipes	16-42	$2,0 \leq t \leq 6,0$	8,0 – 36,0 e.g. AF1 – AF6	≥ 800	U/C

Aluminum composite pipes include the following brand names:

Geberit Mepla, Fränkische Alpex F50 Profi, Rehau Rautitan stabil, GF Sanipex, Prineto Stabil, Kekelit Kelox, TECEflex, Uponor Uni Pipe Plus, Viega SANIFIX Fosta

A.1.8.7 Mixed Seals

A.1.8.7.1 *Mixed seals with electrical cables*

A mix penetrations seal, allows the installation / combination of **all** different types of services acc. Annex 2 in one opening: (distinct small / medium / and large cables see Annex 2).

A.1.8.7.2 *Mixed seals without electrical cables (multiple pipe seal)*

A mix penetrations seal, allows the installation / combination of all different types of services acc. Annex 2 in one opening, excluded cables,

A.1.9 Fixing of HILTI Firestop Cable Collar CFS-RCC

A.1.9.1 Selection of fixing elements

Anchoring solution	Anchor Indication	Drywall	Rigid wall	Floor
Screw anchors:	HUS-H 6x40/5	X	X	X
	HUS-P 6x40/5	X	X	X
Expansion anchor:	HAS M8 20/10		X	X
	HST M8		X	x
Undercut anchor:	HPD M10/8		X	X
Internally threaded anchor:	HKD M8/30		X	X
Hollow core:	HTBS 6/60	X		
	HHD-S M6 25x64	X		
Chemical anchors:	Hilti HY 70		X	X
	Hilti HY 270		X	X
	Hilti MM Plus		X	X
	Hilti HFX		X	X
Others:	DBZ 6/45		X	X
	HHD-S M6 25x64		X	X
	Screws with washer	X		
	threaded rods with nuts and washer	X	X	X

A.1.9.2 Numbere of fixations

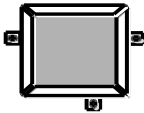
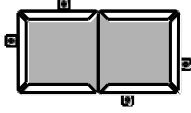
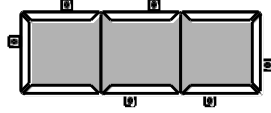
			
Basic configuration Acc. A.1.4 Figure 7	3	4	6
Side configuration Acc. A.1.4. Figure 8	3	3	4
corner configuration Acc. A.1.4. Figure 9	2	3	4

Note:

At least one fixation per side and per housing element. For single basic configuration at least 3 times. Minimum one on the long side of the U-shaped is mandatory. For side and corner configurations, no fixations required at the side where the collar meets the connecting building element (e. g. wall, floor)

A.1.10 Annular spaces

Following separations must be respected:

Unmixed penetrations seals in walls and floors:

Service	minimum distance between any cable and the seal edge (mm)	minimum distance between any two or more cables (mm)
Cables	0	0
Conduits $\varnothing \leq 16$ mm	0	0

Service	minimum distance between any service and the seal top edge (mm)	minimum distance between any service and the seal side edge (mm)	minimum distance between any two or more services (mm)
Conduits $\varnothing > 16$ mm	0	0	20
Waveguides	0	0	20
Plastic pipes	0	0	20
Metal pipes	0	0	20
Aluminium composite pipes	0	0	20
Special applications systems	0	0	0

Mixed penetrations seals in walls:

Distance from – to (mm)	Cables	Conduits	Waveguides	Plastic pipes	Metal pipes comb. Insulation	Metal pipes non-comb. Insulation	Alu composite pipes	Special applications bundles / systems	Seal edge
Cables	0	10	20	20	10	10	10	20	
Conduits	10	0	20	0	20	20	20	20	0
Waveguides	20	20	20	20	20	20	20	20	0
Plastic pipes	20	0	20	20	0	0	0	20	0
Metal pipes comb. Insulation	10	20	20	0	20	10	0	20	0
Metal pipes non-comb. Insulation	10	20	20	0	10	0	0	20	0
Alu composite pipes	10	20	20	0	0	0	20	20	0
Special applications bundles / systems	20	20	20	20	20	20	20	20	0
Seal edge		0	0	0	0	0	0	0	

Mixed penetrations seals in floors:

Distance from – to (mm)	Cables	Conduits	Waveguides	Plastic pipes	Metal pipes comb. Insulation	Metal pipes non-comb. Insulation	Alu composite pipes	Special applications bundles / systems	Seal edge
Cables	0	20	20	20	10	10	10	20	
Conduits	20	20	20	0	20	20	20	20	0
Waveguides	20	20	20	20	20	20	20	20	0
Plastic pipes	20	0	20	20	20	20	20	20	0
Metal pipes comb. Insulation	10	20	20	20	20	10	20	20	0
Metal pipes non-comb. Insulation	10	20	20	20	10	0	20	20	0
Alu composite pipes	10	20	20	20	20	20	20	20	0
Special applications bundles / systems	20	20	20	20	20	20	20	20	0
Seal edge		0	0	0	0	0	0	0	









A.1.11 Distances for pipe and cable support constructions









The distances from the surface of the separating element to the first supporting construction:

- a) Wall (distance from the face of the wall on both sides): $\leq 500\text{mm}$
- b) Floor (distance from upper side of floor): $\leq 500\text{mm}$









A.2 Classifications

A.2.1 Wall $\geq 100\text{mm}$ as described in A.1.1 for basic configuration according to A.1.4

Housing concept Acc. A.1.4	Both sides Acc. 1.2.1			Both sides +foam inlay Acc. 1.2.2			Single sided Acc. 1.2.3		
	Single 	Double 	Triple 	Single 	Double 	Triple 	Single 	Double 	Triple 
Blank seal	EI120	EI120	EI120	EI120	EI90	EI90	EI120	EI90	EI90
Cables (single and multiple)									
Small cables $\varnothing \leq 21\text{ mm}$	EI120	EI90	EI90	EI120	EI90	EI90	EI120	EI90	EI90
Small cables $\varnothing \leq 21\text{ mm}$ bended 90° ,	EI90	EI90	EI90	-	-	-	-	-	-
Medium and large cables $21 \leq \varnothing \leq 80\text{ mm}$	EI90	EI90	EI90	EI90	EI90	EI90	EI90	EI90	EI90
Cable bundle $\varnothing \leq 150\text{ mm}$	EI120	EI90	EI90	EI120	EI90	EI90	EI120	EI90	EI90
Non sheated cables (wires)	EI60	EI60	EI60	-	-	-	-	-	-
Waveguides	EI120	EI120	EI120	-	-	-	EI120	EI90	EI90
Conduits (single and multiple)									
Single conduits $\varnothing \leq 16\text{ mm}$	EI120	EI120	EI120	EI90	EI90	EI90	EI120	EI90	EI90
Single conduits $\varnothing \leq 50\text{ mm}$	EI120	EI120	EI120	-	-	-	-	-	-
Conduit bundle	EI120	EI120	EI120	-	-	-	-	-	-
Special penetration (single and multiple)									
Copper pipes with PE / PEF insulation e.g.Sangi Twin/WicuFlex	EI120	EI120	EI120	-	-	-	EI120	EI90	EI90
Copper pipes with foamed elastomeric insulation	EI120	EI120	EI120	-	-	-	EI120	EI90	EI90
Pipes (single and multiple)									
Combustible Pipes (U/U)	EI120	EI120	EI120	-	-	-	-	-	-
Copper pipes (C/U) with combustible insulation	EI120	EI120	EI120	-	-	-	-	-	-
Copper pipes (C/U) with non combustible insulation	EI120	EI120	EI120	-	-	-	-	-	-
Steel pipes (C/U) with combustible insulation $\varnothing \leq 108\text{mm}$	EI120	EI120	EI120	-	-	-	-	-	-
Steel pipes (C/U) with combustible insulation $\varnothing \leq 114\text{mm}$	EI90	EI90	EI90	-	-	-	-	-	-

Housing concept Acc. A.1.4	Both sides Acc. 1.2.1			Both sides +foam inlay Acc. 1.2.2			Single sided Acc. 1.2.3		
	Single 	Double 	Triple 	Single 	Double 	Triple 	Single 	Double 	Triple 
Steel pipes (C/U) with non combustible insulation $\varnothing \leq 108\text{mm}$	EI120	EI120	EI120	-	-	-	-	-	-
Steel pipes (C/U) with non combustible insulation $\varnothing \leq 114\text{mm}$	EI90	EI90	EI90	-	-	-	-	-	-
Aluminum composite pipes (U/C) with combustible insulation	EI120	EI120	EI120	-	-	-	-	-	-
Mixed Seals acc.A.1.8.7									
Mixed seals without electrical cables	EI120	EI120	EI120	-	-	-	-	-	-
Mixed seals with electrical cables $\varnothing \leq 80\text{mm}$	EI90	EI90	EI90	-	-	-	-	-	-

**A.2.2 Wall $\geq 100\text{mm}$ as described in A.1.1
for corner and side configuration according to A.1.4**

Housing concept Acc. A.1.4	Both sides Acc.1.2.1			Both sides +foam inlay Acc. A.1.2.2			Single sided Acc. 1.2.3		
	Single 	Double 	Triple 	Single 	Double 	Triple 	Single 	Double 	Triple 
Blank seal	EI120	EI120	EI120	EI120	EI90	EI90	EI120	EI90	EI90
Cables (single and multiple)									
Small cables $\varnothing \leq 21 \text{ mm}$	EI120	EI90	EI90	EI120	EI90	EI90	EI120	EI90	EI90
Small cables $\varnothing \leq 21 \text{ mm}$ bended 90° ,	EI90	EI90	EI90	-	-	-	-	-	-
Medium and large cables $21 \leq \varnothing \leq 80 \text{ mm}$	EI90	EI90	EI90	EI90	EI90	EI90	EI90	EI90	EI90
Cable bundle $\varnothing \leq 150 \text{ mm}$	EI120	EI90	EI90	EI120	EI90	EI90	EI120	EI90	EI90
Non sheated cables (wires)	EI60	EI60	EI60	-	-	-	-	-	-
Waveguides	EI120	EI120	EI120	-	-	-	EI120	EI90	EI90
Conduits (single and multiple)									
Single conduits $\varnothing \leq 16 \text{ mm}$	EI120	EI120	EI120	EI90	EI90	EI90	EI120	EI90	EI90
Single conduits $\varnothing \leq 50 \text{ mm}$	EI120	EI120	EI120	-	-	-	-	-	-
Conduit bundle	EI120	EI120	EI120	-	-	-	-	-	-

Housing concept Acc. A.1.4	Both sides Acc.1.2.1			Both sides +foam inlay Acc. A.1.2.2			Single sided Acc. 1.2.3		
	Single 	Double 	Triple 	Single 	Double 	Triple 	Single 	Double 	Triple

Special penetration (single and multiple)

Copper pipes with PE / PEF insulation e.g. Sangi Twin/WicuFlex	EI120	EI120	EI120	-	-	-	EI120	EI90	EI90
Copper pipes with foamed elastomeric insulation	EI120	EI120	EI120	-	-	-	EI120	EI90	EI90









Pipes (single and multiple)

Combustible Pipes (U/U)	EI120	EI120	EI120	-	-	-	-	-	-
Copper pipes (C/U)with combustible insulation	EI120	EI120	EI120	-	-	-	-	-	-
Copper pipes (C/U) with non combustible insulation	EI120	EI120	EI120	-	-	-	-	-	-
Steel pipes (C/U) with combustible insulation $\varnothing \leq 114\text{mm}$	EI90	EI90	EI90	-	-	-	-	-	-
Steel pipes (C/U) with non combustible insulation $\varnothing \leq 114\text{mm}$	EI90	EI90	EI90	-	-	-	-	-	-
Aluminum composite pipes (U/C) with combustible insulation	EI120	EI120	EI120	-	-	-	-	-	-









Mixed Seals acc.A.1.8.7

Mixed seals without electrical cables	EI120	EI120	EI120	-	-	-	-	-	-
Mixed seals with up to large electrical cables	EI90	EI90	EI90	-	-	-	-	-	-



A.2.3 Rigid Wall $\geq 150\text{mm}$ as described in A.1.1 for basic configuration according to A.1.4







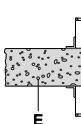

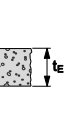
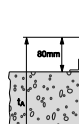
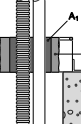
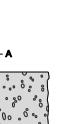
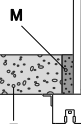
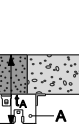
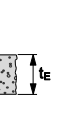
Housing concept Acc.A.1.4	Both sides Acc. A.1.2.1			Both sides + 2 layers CFS-P BA on each side Acc. 1.2.1			Both sides Acc. A.1.2.31		
	Single 	Double 	Triple 	Single 	Double 	Triple 	Single 	Double 	Triple 
Cables (single and multiple)									
Small cables $\varnothing \leq 21 \text{ mm}$	EI120	EI90	EI90	EI120	EI120	EI120	EI120	EI120	EI120
Small cables $\varnothing \leq 21 \text{ mm}$ bended 90° ,	EI120	EI90	EI90	EI120	EI120	EI120	EI120	EI120	EI120
Medium and large cables $21 \leq \varnothing \leq 80 \text{ mm}$	EI90	EI90	EI90	EI120	EI120	EI120	EI120	EI120	EI120
Cable bundle $\varnothing \leq 150 \text{ mm}$	EI120	EI90	EI90	EI120	EI120	EI120	EI120	EI120	EI120
Non sheathed cables (wires)									

A.2.4 Rigid Wall $\geq 150\text{mm}$ as described in A.1.1 for corner and side configuration according to A.1.4









Housing concept Acc. A.1.4	Both sides Acc. A.1.2.1			Both sides + 2 layers CFS-P BA on each side Acc. A.1.2.2			Single sided Acc. A.1.2.3 $t_E = 200\text{mm}$		
	Single 	Double 	Triple 	Single 	Double 	Triple 	Single 	Double 	Triple 
Cables (single and multiple)									
Small cables $\varnothing \leq 21 \text{ mm}$	EI120	EI90	EI90	EI120	EI120	EI120	EI120	EI120	EI120
Small cables $\varnothing \leq 21 \text{ mm}$ bended 90° ,	EI90	EI90	EI90	EI90	EI120	EI120	EI90	EI120	EI120
Medium and large cables $21 \leq \varnothing \leq 80 \text{ mm}$	EI90	EI90	EI90	EI120	EI120	EI120	EI120	EI120	EI120
Cable bundle $\varnothing \leq 150 \text{ mm}$	EI120	Ei90	EI90	EI120	EI120	EI120	EI120	EI120	EI120

A.2.5 Rigid floor $\geq 150\text{mm}$ as described in A.1.1 for basic configuration according to A.1.4

Housing concept Acc. A.1.4	Both sides Acc. A.1.2.1			Both sides +foam inlay Acc. A.1.2.2			Single sided Acc. A.1.2.3		
	Single 	Double 	Triple 	Single 	Double 	Triple 	Single 	Double 	Triple 
Blank seal	EI180	EI180	EI180	EI180	EI180	EI180	EI120	EI120	EI120
Cables (single and multiple)									
Small cables $\varnothing \leq 21 \text{ mm}$	EI180	EI180	EI180	EI180	EI180	EI180	EI180	EI180	EI180
Small cables $\varnothing \leq 21 \text{ mm}$ bended 90° ,	EI180	EI180	EI180	-	-	-	-	-	-
Medium and large cables $21 \leq \varnothing \leq 80 \text{ mm}$	EI90	EI90	EI90	EI90	EI90	EI90	EI90	EI90	EI90
Cable bundle $\varnothing \leq 150 \text{ mm}$	EI120	EI120	EI120	EI120	EI120	EI120	EI120	EI120	EI120
Non sheated cables (wires)	EI90	EI90	EI90	-	-	-	EI120	EI120	EI120
Waveguides	EI180	EI120	EI120	-	-	-	EI120	EI120	EI120
Waveguides – Heliflex	EI120	EI120	EI120	-	-	-	EI120	EI120	EI120
Conduits (single and multiple)									
Single conduits $\varnothing \leq 16 \text{ mm}$	EI180	EI180	EI180	EI90	EI90	EI90	EI180	EI180	EI180
Single conduits $\varnothing \leq 50 \text{ mm}$	EI120	EI120	EI120	-	-	-	-	-	-
Conduit bundle	EI120	EI120	EI120	-	-	-	-	-	-
Special penetration (single and multiple)									
Pre-insulated clima split: Sangi Twin	EI120	EI120	EI120	-	-	-	EI120	EI120	EI120
Pre-insulated clima split: Wicu Flex	EI120	EI120	EI120	-	-	-	EI120	EI120	EI120
Copper pipes with combustible insulation	EI120	EI120	EI120	-	-	-	EI120	EI120	EI120
Pipes (single and multiple)									
Combustible Pipes (U/U)	EI180	EI180	EI180	-	-	-	-	-	-
Copper pipes (C/U) with combustible insulation	EI180	EI120	EI120	-	-	-	-	-	-
Copper pipes (C/U) with non combustible insulation up to 28mm	EI180	EI120	EI120	-	-	-	-	-	-
Copper pipes (C/U) with non combustible insulation up to 42mm	EI120	EI120	EI120	-	-	-	-	-	-
Steel pipes (C/U) with combustible insulation up to 114mm	EI120	EI120	EI120	-	-	-	-	-	-

Housing concept Acc. A.1.4	Both sides Acc. A.1.2.1			Both sides +foam inlay Acc. A.1.2.2			Single sided Acc. A.1.2.3		
	Single 	Double 	Triple 	Single 	Double 	Triple 	Single 	Double 	Triple 
Steel pipes (C/U) with non combustible insulation up to 108mm	EI120	EI120	EI120	-	-	-	-	-	-
Aluminum composite pipes (U/C) with combustible insulation	EI180	EI180	EI180	-	-	-	-	-	-
Mixed Seals acc.A.1.8.7									
Mixed seals with small electrical cables	EI120	EI120	EI120	-	-	-	-	-	-
Mixed seals with up to large electrical cables	EI90	EI90	EI90	-	-	-	-	-	-

**A.2.6 Rigid floor $\geq 150\text{mm}$ as described in A.1.1
for corner and side configuration according to A.1.4**









Housing concept Acc. A.1.4	Both sides Acc. A.1.2.1			Both sides + foam inlay Acc. A.1.2.2			Single sided Acc. A.1.2.34		
	Single 	Double 	Triple 	Single 	Double 	Triple 	Single 	Double 	Triple 
Blank seal	EI180	EI180	EI180	EI180	EI180	EI180	EI120	EI120	EI120
Cables (single and multiple)									
Small cables $\varnothing \leq 21 \text{ mm}$	EI180	EI180	EI180	EI180	EI180	EI180	EI180	EI180	EI180
Small cables $\varnothing \leq 21 \text{ mm}$ bended 90° ,									
Medium and large cables $21 \leq \varnothing \leq 80 \text{ mm}$	EI90	EI90	EI90	EI90	EI90	EI90	EI90	EI90	EI90
Cable bundle $\varnothing \leq 150 \text{ mm}$	EI120	EI120	EI120	EI120	EI180	EI180	EI120	EI120	EI120
Non sheated cables (wires)	EI90	EI90	EI90	-	-	-	EI120	EI120	EI120
Waveguides	EI120	EI120	EI120	-	-	-	EI120	EI120	EI120
Conduits (single and multiple)									
Single conduits $\varnothing \leq 16 \text{ mm}$	EI180	EI180	EI180	EI90	EI90	EI90	EI180	EI180	EI180
Single conduits $\varnothing \leq 50 \text{ mm}$	EI120	EI120	EI120	-	-	-	-	-	-
Conduit bundle	EI120	EI120	EI120	-	-	-	-	-	-
Special penetration (single and multiple)									
Pre-insulated clima split: Sangi Twin	EI120	EI120	EI120	-	-	-	EI120	EI120	EI120
Pre-insulated clima split: Wicu Flex	EI120	EI120	EI120	-	-	-	EI120	EI120	EI120
Copper pipes with combustible insulation	EI120	EI120	EI120	-	-	-	EI120	EI120	EI120
Pipes (single and multiple)									
Combustible Pipes (U/U)	EI180	EI180	EI180	-	-	-	-	-	-
Copper pipes (C/U) with combustible insulation 42mm	EI180	EI120	EI120	-	-	-	-	-	-
Copper pipes (C/U) with combustible insulation	EI120	EI120	EI120	-	-	-	-	-	-
Copper pipes (C/U) with non combustible insulation	EI120	EI120	EI120	-	-	-	-	-	-
Steel pipes (C/U) with combustible insulation 114mm	EI180	EI120	EI120	-	-	-	-	-	-
Steel pipes (C/U) with combustible insulation up to 114mm	EI120	EI120	EI120	-	-	-	-	-	-
Housing concept Acc. A.1.4	Both sides Acc. A.1.2.1			Both sides + foam inlay Acc. A.1.2.2			Single sided Acc. A.1.2.34		

	Single 	Double 	Triple 	Single 	Double 	Triple 	Single 	Double 	Triple
Steel pipes (C/U) with non combustible insulation up to 114mm	EI120	EI120	EI120	-	-	-	-	-	-
Aluminum composite pipes (U/C) with combustible insulation	EI180	EI180	EI180	-	-	-	-	-	-
Mixed Seals acc.A.1.8.7									
Mixed seals with small electrical cables	EI120	EI120	EI120	-	-	-	-	-	-
Mixed seals with up to large electrical cables	EI90	EI90	EI90	-	-	-	-	-	-

A.2.7 Rigid floor $\geq 150\text{mm}$ as described in A.1.1 for basic configuration according to A.1.4

Housing concept Acc. A.1.4	Both sides Acc. A.1.2.1			Both sides + 2 layers CFS-P BA on top side Acc. A.1.2.2			Both sides + 2 layers CFS-P BA on top side t_E = 200mm Acc. A.1.2.1		
	Single 	Double 	Triple 	Single 	Double 	Triple 	Single 	Double 	Triple
Blank seal									
Cables (single and multiple)									
Small cables $\varnothing \leq 21 \text{ mm}$				EI180	EI180	EI180	EI180	EI180	EI180
Small cables $\varnothing \leq 21 \text{ mm}$ bended 90°				EI180	EI180	EI180	EI180	EI180	EI180
Medium and large cables $21 \leq \varnothing \leq 80 \text{ mm}$				EI180	EI180	EI180	EI180	EI180	EI180
Cable bundle $\varnothing \leq 150 \text{ mm}$				EI120	EI120	EI120	EI120	EI120	EI120

**A.2.8 Rigid floor $\geq 150\text{mm}$ as described in A.1.1
for corner and side configuration according to A.1.4**

Housing concept Acc. A.1.4	Both sides Acc. A.1.2.1			Both sides + 2 Layers CFS-P BA on top side Acc. A.1.2.1			Both sides + 2 Layers CFS-P BA on top side $t_E = 200\text{mm}$ Acc. A.1.2.1		
	Single 	Double 	Triple 	Single 	Double 	Triple 	Single 	Double 	Triple 
Cables (single and multiple)									
Small cables $\varnothing \leq 21 \text{ mm}$				EI180	EI180	EI180	EI180	EI180	EI180
Small cables $\varnothing \leq 21 \text{ mm}$ bended 90° ,									
Medium and large cables $21 \leq \varnothing \leq 80 \text{ mm}$				EI180	EI180	EI180	EI180	EI180	EI180
Cable bundle $\varnothing \leq 150 \text{ mm}$				EI120	EI120	EI120	EI120	EI120	EI120

A.3 Abbreviations and referenced documents

A.3.1 Abbreviations used in drawings

A	Hilti Firestop Cable Collar
E	Building element (rigid or flexible wall construction, floor)
t_E	Thickness of building element
t_A	Thickness of seal
A ₁	Hilti Firestop Foam CFS-F FX
A _{1a}	Hilti Firestop Filler CFS-FIL
E ₁	Gypsum frame
B	2 layers CFS-P BA
W _A	Width of frame
W	Width of opening
M	Mortar
W ₁	Opening dimension
A'	Old material (e.g. paper, boards, foams, intumescent products, ...)
C ₁	Cables
C ₂	Condensate pipe
C ₃	Copper pipe
S ₁	Distance between penetration and seal edge
S _a	Horizontal distance between cable collars linear
S _b	Vertical distance between cable collars in cluster arrangement

A.3.2 References to standards mentioned in the ETA

DIN EN 980	Graphical symbols for use in the labelling of medical devices
EN 1366-3	Fire resistance tests for service installations - Part 3: Penetration seals
EN ISO 717-1	Acoustics – Rating of sound insulation of buildings and of building elements – Part 1: Airborne sound insulation
EN 10140-2	Acoustics - Laboratory measurement of sound insulation of building elements - Part 2: Measurement of airborne sound insulation
EN 1026	Windows and doors - Air permeability - Test method
EN 12086	Thermal insulating products for building applications - Determination of water vapour transmission properties
EN ISO 12572	Hygrothermal performance of building materials and products - Determination of water vapour transmission properties (ISO 12572:2001);
EN 1226	Plastics piping systems - Glass-reinforced thermosetting plastics (GRP) pipes - Test method to prove the resistance to initial ring deflection
EN 12664	Thermal performance of building materials and products - Determination of thermal resistance by means of guarded hot plate and heat flow meter methods - Dry and moist products with medium and low thermal resistance
EN 12667	Thermal performance of building materials and products – Determination of thermal resistance by means of guarded hot plate and heat flow meter methods – Products of high and medium thermal resistance
EN 12939	Thermal performance of building materials and products - Determination of thermal resistance by means of guarded hot plate and heat flow meter methods - Thick products of high and medium thermal resistance;
EN 13501-1	Fire classification of construction products and building elements – Part 1: Classification using test data from reaction to fire tests
EN 13501-2	Fire classification of construction products and building elements – Part 2: Classification using test data from fire resistance tests
EN 1451-1	Plastics piping systems for soil and waste discharge (low and high temperature) within the building structure - Polypropylene (PP) – Part 1: Specifications for pipes, fittings and the system
EN 1451-2	Plastics piping systems for water supply and for buried and above-ground drainage and sewerage under pressure - Unplasticized poly(vinyl chloride) (PVC-U) - Part 2: Pipes
EN 520	Gypsum plasterboards - Definitions, requirements and test methods;
EN ISO 15494	Plastics piping systems for industrial applications - Polybuten (PB), polyethylene (PE) and polypropylene (PP) - Specifications for components and the system; Metric series
EOTA TR 001	Determination of impact resistance of panels and panel assemblies
EOTA TR 024	Characterization, Aspects of Durability and Factory Production Control for Reactive Materials, Components and Products
ETAG 026	Fire Stopping and Fire Sealing Products