

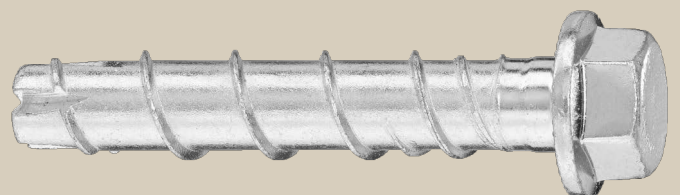

# Hilti HUS3 SCREW ANCHOR









**Technical Datasheet**





**Update: Jul-20**

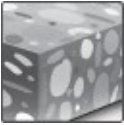

# HUS3 Screw anchor

Ultimate performance screw anchor for single point fastening

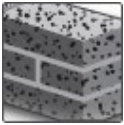
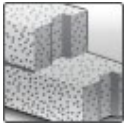
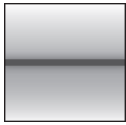
Anchor version		Benefits
	HUS3-H (6-14)	- High productivity - less drilling and fewer operations than with conventional anchors
	HUS3-HF (8-14)	- ETA approval for cracked and non-cracked concrete - ETA approval for Seismic C1 and C2
	HUS3-C (8-10)	- ETA approval for adjustability (unscrew-rescrew) - High loads
	HUS3-A (6)	- Small edge and spacing distance
	HUS3-P (6)	- abZ (DIBt) approval for reusability in fresh concrete ( $f_{ck, cube} = 10/15/20$ Nmm <sup>2</sup> ) for temporary applications
	HUS3-PL (6)	- Three embedment depths for maximum design flexibility
	HUS3-PS (6)	- No cleaning required
	HUS3-I (6)	- HUS3-HF with multilayer coatings for additional corrosion protection - Forged-on washer and hexagon head with no protruding thread
	HUS3-I Flex (6)	- Through fastening

Base material				Load conditions		
						
Concrete (non-cracked)	Concrete (cracked)	Solid brick	Autoclaved aerated concrete	Static / quasi-static	Seismic ETA-C1,C2	Fire resistance

Installation conditions	Other information			
				
Small edge distance and spacing	European Technical Assessment	CE conformity	PROFIS Anchor design software	DIBt Approval Reusability

### Approvals / certificates

Description	Authority / Laboratory	No. / date of issue
European Technical Assessment	DIBt, Berlin	ETA-13/1038 / 28-07-2020
Fire test report	DIBt, Berlin	ETA-13/1038 / 28-07-2020

a) All data given in this section according ETA-13/1038 issue 22-07-2019.

## Static and quasi-static loading data (for a single anchor)

### All data in this section applies to:

- Correct setting (See setting instruction)
- No edge distance and spacing influence
- Steel failure
- Minimum base material thickness
- Concrete C 20/25,  $f_{ck} = 20 \text{ N/mm}^2$
- Hilti technical data calculated acc. to EN 1992-4

### Anchorage depth

Anchor size	6		8			10			14		
Type	HUS3- H,C,A, I, P	H,C,A, I,I-flex	H,C,A,			H,C,HF			H,HF		
Nominal embedmenth depl [mm]	$h_{nom1}$	$h_{nom2}$	$h_{nom1}$	$h_{nom2}$	$h_{nom3}$	$h_{nom1}$	$h_{nom2}$	$h_{nom3}$	$h_{nom1}$	$h_{nom2}$	$h_{nom3}$
	40	55	50	60	70	55	75	85	65	85	115

### Characteristic resistance

Anchor size	6		8			10			14			
Type	HUS3- H,C,A, I, P	H,C,A, I,I-flex	H,C,HF			H,C,HF			H,HF			
<b>Non-cracked concrete</b>												
Tension $N_{Rk}$	[kN]	7,0	9,0	9,0	12,0	16,0	12,0	20,0	27,0	17,0	26,6	43,3
Shear $V_{Rk}$	[kN]	8,1	12,5	12,4	19,0	22,0	13,2	30,0	34,0	34,1	53,1	62,0
<b>Cracked concrete</b>												
Tension $N_{Rk}$	[kN]	2,5	6,0	6,0	9,0	12,0	9,0	15,0	18,9	11,9	18,6	30,0
Shear $V_{Rk}$	[kN]	5,7	12,5	8,7	19,0	22,0	9,2	30,0	34,0	23,8	37,2	60,6

### Design resistance

Anchor size	6		8			10			14			
Type	HUS3- H,C,A, I, P	H,C,A, I,	H,C,HF			H,C,HF			H,HF			
<b>Non-cracked concrete</b>												
Tension $N_{Rd}$	[kN]	3,9	5,0	6,0	8,0	10,7	8,0	13,3	18,0	11,4	17,7	28,8
Shear $V_{Rd}$	[kN]	5,4	8,3	8,3	12,7	14,7	8,8	20,0	22,7	22,7	35,4	41,3
<b>Cracked concrete</b>												
Tension $N_{Rd}$	[kN]	1,4	3,3	4,0	6,0	8,0	6,0	10,0	12,6	7,9	12,4	20,0
Shear $V_{Rd}$	[kN]	3,8	8,3	5,8	12,7	14,7	6,2	20,0	22,7	15,9	24,8	40,4

### Recommended loads<sup>a)</sup>

Anchor size	6		8			10			14			
Type	HUS3- H,C,A, I, P	H,C,A, I,I-flex	H,C,HF			H,C,HF			H,HF			
<b>Non-cracked concrete</b>												
Tension $N_{Rec}$	[kN]	2,8	3,6	4,3	5,7	7,6	5,7	9,5	12,9	8,1	12,6	20,6
Shear $V_{Rec}$	[kN]	3,9	5,9	5,9	9,1	10,5	6,3	14,3	16,2	16,2	25,3	29,5
<b>Cracked concrete</b>												
Tension $N_{Rec}$	[kN]	1,0	2,4	2,9	4,3	5,7	4,3	7,1	9,0	5,6	8,9	14,3
Shear $V_{Rec}$	[kN]	2,7	5,9	4,1	9,1	10,5	4,4	14,3	16,2	11,4	17,7	28,9

a) With overall partial safety factor for action  $\gamma = 1,4$ . The partial safety factors for action depend on the type of loading and shall be taken from national regulations.

## Seismic loading data (for single anchor)

### All data in this section applies to:

- Correct setting (See setting instruction)
- No edge distance and spacing influence
- Steel failure
- Minimum base material thickness
- Concrete C 20/25,  $f_{ck,cube} = 25 \text{ N/mm}^2$
- $\alpha_{gap} = 1,0$  (using Hilti seismic filling set)

### Anchorage depth for seismic C2

Anchor size			8	10	14
Type	HUS3 -		H,C,HF	H,C,HF	H,C,HF
Nominal anchor. depth range	$h_{nom}$	[mm]	$h_{nom3}$	$h_{nom3}$	$h_{nom3}$
			70	85	115
Effective anchorage depth	$h_{eff}$	[mm]	54,9	67,1	91,8

### Characteristic resistance in case of seismic performance category C2

Anchor size			8	10	14
<b>with Hilti filling set (<math>\alpha_{gap} = 1,0</math>) (HUS3-H only)</b>					
Type	HUS3 -		H	H	H
Tension $N_{Rk,seis}$		[kN]	3,2	9,4	17,7
Shear $V_{Rk,seis}$		[kN]	14,7	25,6	46,5
<b>without Hilti filling set (<math>\alpha_{gap} = 0,5</math>)</b>					
Type	HUS3		H,C,HF	H,C,HF	H,C,HF
Tension $N_{Rk,seis}$		[kN]	3,2	9,4	17,7
Shear $V_{Rk,seis}$		[kN]	5,4	8,9	17,2

### Design resistance in case of seismic performance category C2

Anchor size			8	10	14
<b>with Hilti filling set (<math>\alpha_{gap} = 1,0</math>) (HUS3-H only)</b>					
Type	HUS3 -		H	H	H
Tension $N_{Rd,seis}$		[kN]	2,1	6,3	11,8
Shear $V_{Rd,seis}$		[kN]	9,8	17,1	31,1
<b>without Hilti filling set (<math>\alpha_{gap} = 0,5</math>)</b>					
Type	HUS3		H,C,HF	H,C,HF	H,C,HF
Tension $N_{Rd,seis}$		[kN]	2,1	6,3	11,8
Shear $V_{Rd,seis}$		[kN]	3,6	5,9	11,5

### Anchorage depth for seismic C1

Anchor size		6		8		10		14	
Type	HUS3-	H, C, A, I, P		H,C,HF		H,C,HF		H,C,HF	
Nominal anchorage depth range	$h_{nom}$ [mm]	$h_{nom1}$	$h_{nom2}$	$h_{nom2}$	$h_{nom3}$	$h_{nom2}$	$h_{nom3}$	$h_{nom2}$	$h_{nom3}$
		40	55	60	70	75	85	85	115
Effective anchorage depth	$h_{ef}$ [mm]	30	42	46,4	54,9	58,6	67,1	66,3	91,8

### Characteristic resistance in case of seismic performance category C1

Anchor size		6		8		10		14	
with Hilti filling set ( $\alpha_{gap} = 1,0$ ) (HUS3-H only)									
Type	HUS3 -	H, C, A, I, P		H,C,HF		H,C,HF		H,C,HF	
Tension $N_{Rk,seis}$	[kN]	2,5-	4,0	9,0	12,0	13,8	16,8	16,5	26,9
Shear $V_{Rk,seis}$		5,0	5,0	11,9	11,9	16,8	17,7	22,5	34,5
without Hilti filling set ( $\alpha_{gap} = 0,5$ )									
Type	HUS3 -	H, C, A, I, P		H,C,HF		H,C,HF		H,C,HF	
Tension $N_{Rk,seis}$	[kN]	2,5	4,0	9,0	12,0	13,7	16,8	16,5	26,9
Shear $V_{Rk,seis}$		2,5	2,5	6,0	6,0	8,4	8,9	11,3	17,3

### Design resistance in case of seismic performance category C1

Anchor size		6		8		10		14	
with Hilti filling set ( $\alpha_{gap} = 1,0$ ) (HUS3-H only)									
Type	HUS3 -	H, C, A, I, P		H,C,HF		H,C,HF		H,C,HF	
Tension $N_{Rd,seis}$	[kN]	1,4	2,2	6,0	8,0	9,2	11,2	11,0	17,9
Shear $V_{Rd,seis}$		3,3	3,3	7,9	7,9	11,2	11,8	15,0	23,0
without Hilti filling set ( $\alpha_{gap} = 0,5$ )									
Type	HUS3 -	H, C, A, I, P		H,C,HF		H,C,HF		H,C,HF	
Tension $N_{Rd,seis}$	[kN]	1,4	2,2	6,0	8,0	9,1	11,2	11,0	17,9
Shear $V_{Rd,seis}$		1,7	1,7	4,0	4,0	5,6	5,9	7,5	11,5

## Fire resistance

### All data in this section applies to:

- Correct setting (see setting instruction)
- No edge distance and spacing influence
- Minimum base material thickness
- For more fire resistance data please see the full ETA-13/1038 report.

### Recommended loads under fire exposure<sup>1)</sup>

Anchor size			6		
Type	HUS3-		H, C, A, P, PS, PL, I, I-flex		
Nominal embedment depth	$h_{nom}$	[mm]	40		55
<b>Steel failure for tension and shear load (<math>F_{Rec,s,fi} = N_{Rec,s,fi} = V_{Rec,s,fi}</math>)</b>					
Recommended tensile and shear load	R30	$F_{Rec,s,fi}$ [kN]	0,5		1,6
	R120	$F_{Rec,s,fi}$ [kN]	0,4		0,7
	R30	$M^0_{Rec,s,fi}$ [Nm]	0,4		1,4
	R120	$M^0_{Rec,s,fi}$ [Nm]	0,3		0,6
<b>Pull-out failure</b>					
Recommended resistance	R30 to R90	$N_{Rec,p,fi}$ [kN]	0,6		1,5
	R120	$N_{Rec,p,fi}$ [kN]	0,5		1,2
<b>Concrete cone failure</b>					
Edge distance <sup>2)</sup>	R30 to R120	$c_{cr,fi}$ [mm]	2 $h_{ef}$		
Spacing	R30 to R120	$s_{cr,fi}$ [mm]	2 $c_{cr,fi}$		
<b>Concrete pry-out failure</b>					
	R30 to R120	k [-]	1,0		1,5
The anchorage depth has to be increased for wet concrete by at least 30 mm compared to the given value.					

- 1) The recommended loads under fire exposure include a safety factor for resistance under fire exposure  $\gamma_{Ms,fire} = 1,0$  and the partial safety factor for action  $\gamma_{Ms,fire} = 1,0$ .
- 2) In case of fire attack from more than one side, the minimum edge distance shall be  $\geq 300$  mm.

### Recommended loads under fire exposure<sup>1)</sup>

Anchor size			8			10			14		
Type	HUS3-		H, HF			H, HF			H, HF		
Nominal embedment depth	$h_{nom}$	[mm]	$h_{nom1}$	$h_{nom2}$	$h_{nom3}$	$h_{nom1}$	$h_{nom2}$	$h_{nom3}$	$h_{nom1}$	$h_{nom2}$	$h_{nom3}$
			50	60	70	55	75	85	65	85	115
<b>Steel failure for tension and shear load (<math>F_{Rec,s,fi} = N_{Rec,s,fi} = V_{Rec,s,fi}</math>)</b>											
Recommended tensile and shear load	R30	$F_{Rec,s,fi}$ [kN]	3,2	3,5	3,8	6,1	6,2	10,4	10,6		
	R120	$F_{Rec,s,fi}$ [kN]	1,2	1,2	1,5	2,4	2,5	4,0	4,3		
	R30	$M^0_{Rec,s,fi}$ [Nm]	3,8	4,1	4,4	9,1	9,2	20,4	20,6		
	R120	$M^0_{Rec,s,fi}$ [Nm]	1,5	1,4	1,7	3,5	3,7	7,9	8,3		
<b>Pull-out failure</b>											
Recommended resistance	R30 to R90	$N_{Rec,p,fi}$ [kN]	1,5	2,3	3,0	2,4	4,0	4,9	3,1	4,8	7,8
	R120	$N_{Rec,p,fi}$ [kN]	1,2	1,8	2,4	1,9	3,2	3,9	2,5	3,8	6,3
<b>Concrete cone failure</b>											
Characteristic resistance	R30 to R90	$N^0_{Rec,p,fi}$ [kN]	1,8	2,6	4,0	2,0	4,7	6,6	3,0	6,4	14,4
	R120	$N^0_{Rec,p,fi}$ [kN]	1,4	2,1	3,2	1,6	3,8	5,3	2,4	5,1	11,5
Edge distance <sup>2)</sup>	R30 to R120	$c_{cr,fi}$ [mm]	2 $h_{ef}$								
Spacing	R30 to R120	$s_{cr,fi}$ [mm]	2 $c_{cr,fi}$								
<b>Concrete pry-out failure</b>											
	R30 to R120	k [-]	1,0	2,0	1,0	2,0					
The anchorage depth has to be increased for wet concrete by at least 30 mm compared to the given value.											

- 1) The recommended loads under fire exposure include a safety factor for resistance under fire exposure  $\gamma_{Ms,fire} = 1,0$  and the partial safety factor for action  $\gamma_{Ms,fire} = 1,0$ .
- 2) In case of fire attack from more than one side, the minimum edge distance shall be  $\geq 300$  mm.

### Recommended loads under fire exposure<sup>1)</sup>

Anchor size			8			10		
Type			C			C		
		HUS3-	h <sub>nom1</sub>	h <sub>nom2</sub>	h <sub>nom3</sub>	h <sub>nom1</sub>	h <sub>nom2</sub>	h <sub>nom3</sub>
Nominal embedment depth	h <sub>nom</sub>	[mm]	50	60	70	55	75	85
<b>Steel failure for tension and shear load (F<sub>Rec,s,fi</sub>=N<sub>Rec,s,fi</sub>=V<sub>Rec,s,fi</sub>)</b>								
Recommended tensile and shear load	R30	F <sub>Rec,s,fi</sub> [kN]	0,5			1,2		
	R120	F <sub>Rec,s,fi</sub> [kN]	0,2			0,6		
	R30	M <sup>0</sup> <sub>Rec,s</sub> [Nm]	0,6			1,7		
	R120	M <sup>0</sup> <sub>Rec,s</sub> [Nm]	0,3			0,9		
<b>Pull-out failure</b>								
Recommended resistance	R30 to R90	N <sub>Rec,p,fi</sub> [kN]	1,5	2,3	3,0	2,4	4,0	5,0
	R120	N <sub>Rec,p,fi</sub> [kN]	1,2	1,8	2,4	1,9	3,2	4,0
<b>Concrete cone failure</b>								
Characteristic resistance	R30 to R90	N <sup>0</sup> <sub>Rec,p</sub> [kN]	1,8	2,6	4,0	2,0	4,7	6,6
	R120	N <sup>0</sup> <sub>Rec,p</sub> [kN]	1,5	2,1	3,2	1,6	3,8	5,3
Edge distance <sup>2)</sup>	R30 to R120	c <sub>cr,fi</sub> [m]	2 h <sub>ef</sub>					
Spacing	R30 to R120	s <sub>cr,fi</sub> [m]	2 c <sub>cr,fi</sub>					
<b>Concrete pry-out failure</b>								
R30 to R120			k	[-]	1,0	2,0	1,0	2,0
The anchorage depth has to be increased for wet concrete by at least 30 mm compared to the given value.								

- 1) The recommended loads under fire exposure include a safety factor for resistance under fire exposure  $\gamma_{Ms,fire} = 1,0$  and the partial safety factor for action  $\gamma_{Ms,fire} = 1,0$ .
- 2) In case of fire attack from more than one side, the minimum edge distance shall be  $\geq 300$  mm.

## Materials

### Mechanical properties

Anchor size		6	8	10	14
Type	HUS3-	H,C,A,I, I-flex,P,PS,PL	H,C,HF	H,C,HF	H,HF
Nominal tensile strength f <sub>uk</sub>	[N/mm <sup>2</sup> ]	930	810	805	730
Yield strength f <sub>yk</sub>	[N/mm <sup>2</sup> ]	745	695	690	630
Stressed cross-section A <sub>s</sub>	[mm <sup>2</sup> ]	26,9	48,4	77,0	131,7
Moment of resistance W	[mm <sup>3</sup> ]	19,6	47	95	213
Characteristic bending resistance M <sup>0</sup> <sub>Rk,s</sub>	[Nm]	21	46	92	187

### Material quality

Type	Material
HUS3 - H,A,C,P,PS, PL,I,I-Flex	Carbon steel, galvanized
HUS3 - HF	Carbon steel, multi-layer coating <sup>a)</sup>

- a) Multi-layer coating provides a higher corrosion resistance compared to regular hot dip galvanized (HDG) systems with a 40µm coating thickness.

### Head configuration

Type	Part		
HUS3-H HUS3-HF	Hexagonal head		
HUS3-C	Countersunk head		
HUS3-A	External thread		
HUS3-P	Pan head		
HUS3-PS	Pan head (small)		
HUS3-PL	Pan head (large)		
HUS3-I	Internal thread		
HUS3-I Flex	External thread		

### Anchor dimensions

Anchor size		6	8	10	14
Type	HUS3-	H,C,A,I, I-flex,P,PS,PL	H,C,HF	H,C,HF	H,HF
Threaded outer diameter	$d_t$ [mm]	7,85	10,30	12,40	16,85
Core diameter	$d_k$ [mm]	5,85	7,85	9,90	12,95
Shaft diameter	$d_s$ [mm]	6,15	8,45	10,55	13,80
Diameter of integrated washer	$d_i$ [mm]	16,50	17,50	20,50	29,0
Stressed section	$A_s$ [mm <sup>2</sup> ]	26,9	48,4	77,0	131,7

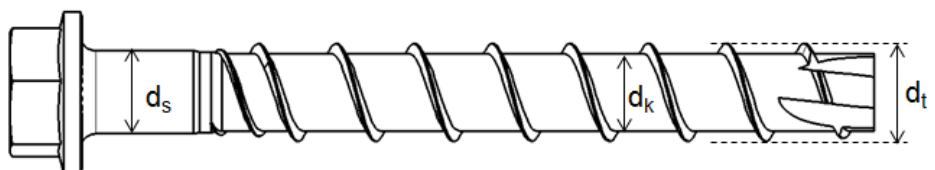

**HUS3:** Hilti Universal Screw 3<sup>rd</sup> generation

**H:** Hexagonal head

**10:** Screw diameter

**45/25/15:** Maximum thickness fixture  $t_{fix1}/t_{fix2}/t_{fix3}$  related to the embedment depth  $h_{nom1}/h_{nom2}/h_{nom3}$  (see Annex B3).



### Screw length and thickness of fixture for HUS3<sup>1)</sup>

Anchor size		6											
Nominal embedment depth [mm]		h <sub>nom1</sub>						h <sub>nom2</sub>					
		40						55					
Type		H	C	A	I / I-	P	PS /	H	C	A	I / I-	P	PS /
Thickness of fixture		t <sub>fix</sub>	t <sub>fix</sub>	t <sub>fix</sub>	t <sub>fix</sub>	t <sub>fix</sub>	t <sub>fix</sub>	t <sub>fix</sub>	t <sub>fix</sub>	t <sub>fix</sub>	t <sub>fix</sub>	t <sub>fix</sub>	t <sub>fix</sub>
Length of screw [mm]	40	-	-	0	0	-	-	-	-	-	-	-	-
	45	5	5	5	5	5	5	-	-	-	-	-	-
	55	-	-	15	15	-	-	-	-	0	0	-	-
	60	20	20	-	-	20	20	5	5	-	-	5	5
	70	-	30	-	-	-	-	-	15	-	-	-	-
	80	40	-	-	-	45	-	25	-	-	-	25	-
	100	60	-	-	-	-	-	45	-	-	-	-	-
	120	80	-	-	-	-	-	65	-	-	-	-	-
	135	-	-	95	-	-	-	-	-	80	-	-	-
	155	-	-	115	-	-	-	-	-	100	-	-	-
	175	-	-	135	-	-	-	-	-	120	-	-	-
195	-	-	155	-	-	-	-	-	140	-	-	-	

1) Non-standard lengths, in the range 55 mm ≤ L ≤ 195 mm, are also in the scope of this ETA.

### Screw length and thickness of fixture for HUS3-C<sup>1)</sup>

Anchor size		8			10		
Nominal embedment depth [mm]		h <sub>nom1</sub>	h <sub>nom2</sub>	h <sub>nom3</sub>	h <sub>nom1</sub>	h <sub>nom2</sub>	h <sub>nom3</sub>
		50	60	70	55	75	85
Thickness of fixture		t <sub>fix1</sub>	t <sub>fix2</sub>	t <sub>fix3</sub>	t <sub>fix1</sub>	t <sub>fix2</sub>	t <sub>fix3</sub>
Length of screw [mm]	65	15	5	-	-	-	-
	70	-	-	-	15	-	-
	75	25	15	-	-	-	-
	85	35	25	15	-	-	-
	90	-	-	-	35	15	-
	100	-	-	-	45	25	15

1) Non-standard lengths, in the range 65 mm ≤ L ≤ 100 mm, are also in the scope of this ETA.

### Screw length and thickness of fixture for HUS3-H and HUS3-HF<sup>1)</sup>

Anchor size		8			10			14		
Nominal embedment depth [mm]		h <sub>nom1</sub>	h <sub>nom2</sub>	h <sub>nom3</sub>	h <sub>nom1</sub>	h <sub>nom2</sub>	h <sub>nom3</sub>	h <sub>nom1</sub>	h <sub>nom2</sub>	h <sub>nom3</sub>
		50	60	70	55	75	85	65	85	115
Thickness of fixture		t <sub>fix1</sub>	t <sub>fix2</sub>	t <sub>fix3</sub>	t <sub>fix1</sub>	t <sub>fix2</sub>	t <sub>fix3</sub>	t <sub>fix1</sub>	t <sub>fix2</sub>	t <sub>fix3</sub>
Length of screw [mm]	55	5	-	-	-	-	-	-	-	-
	60	-	-	-	5	-	-	-	-	-
	65	15	5	-	-	-	-	-	-	-
	70	-	-	-	15	-	-	-	-	-
	75	25	15	5	-	-	-	10	-	-
	80	-	-	-	25	5	-	-	-	-
	85	35	25	15	-	-	-	-	-	-
	90	-	-	-	35	15	5	-	-	-
	100	50	40	30	45	25	15	35	15	-
	110	-	-	-	55	35	25	-	-	-
	120	70	60	50	-	-	-	-	-	-
	130	-	-	-	75	55	45	65	45	15
	150	100	90	80	95	75	65	85	65	35

1) Non-standard lengths, in the range 55 mm ≤ L ≤ 150 mm, are also in the scope of this ETA.

2) HUS3-HF available for size 14 with h<sub>nom1</sub> and h<sub>nom2</sub> only.

## Setting information

### Setting details

Anchor size			6					
Type	HUS3-		H	C	A	P, PS	I-Flex	PL
Nominal diameter of drill bit	$d_0$	[mm]	6					
Cutting diameter of drill bit	$d_{cut} \leq$	[mm]	6,4					
Clearance hole diameter	$d_f \leq$	[mm]	9					
Wrench size	SW	[mm]	13	-	13	-	13	-
Countersunk head diameter	$d_h$	[mm]	-	11,5	-			
Torx size	TX	-	-	30	-	30	-	30
Depth of drill hole in floor/wall position	$h_1 \geq$	[mm]	$h_{nom} + 10 \text{ mm}$					
Depth of drill hole ceiling	$h_1 \geq$	[mm]	$h_{nom} + 3 \text{ mm}$					
Maximum Installation Torque	$T_{inst, max}$	[Nm]	25					

### Setting details

Anchor size			8			10			14		
Type	HUS3-		H, HF, C			H, HF, C			H, HF		H
Nominal embedment depth	[mm]		$h_{nom1}$	$h_{nom2}$	$h_{nom3}$	$h_{nom1}$	$h_{nom2}$	$h_{nom3}$	$h_{nom1}$	$h_{nom2}$	$h_{nom3}$
			50	60	70	55	75	85	65	85	115
Nominal diameter of drill bit	$d_0$	[mm]	8			10			14		
Cutting diameter of drill bit	$d_{cut} \leq$	[mm]	8,45			10,45			14,50		
Clearance hole diameter	$d_f \leq$	[mm]	12			14			18		
Wrench size	SW	[mm]	13			15			21		
Countersunk head diameter	$d_h$	[mm]	18			21			-		
Torx size	TX	-	45			50			-		
Depth of drill hole in floor/wall position	$h_1 \geq$	[mm]	60	70	80	65	85	95	75	95	125
Depth of drill hole (with adjustability setting process)	$h_1 \geq$	[mm]	-	80	90	-	95	105	-		

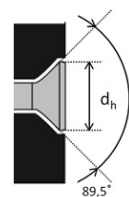
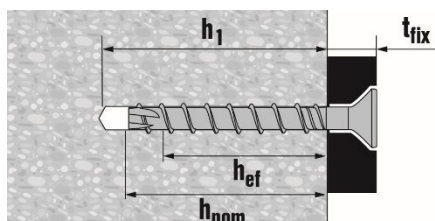
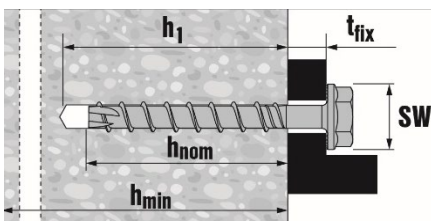

### Installation equipment

Anchor size	6	8	10	14
Type	HUS3- H,C,A,I, I-flex,P,PS,PL	H,C,HF	H,C,HF	H,HF
Rotary hammer	TE 2 -TE 7	TE 2 – TE 30		
Drill bit for concrete, solid clay brick and solid sand-lime brick	CX 6	CX 8	CX 10	CX 14
Drill bit for aerated concrete	CX 5	CX 6	CX 8	-
Socket wrench insert	S-NSD 13 ½ L	SI-S ½“ 13S	SI-S ½“ 15S	SI-S ½“ 21S
Torx	TX30	S-SY TX45	S-SY TX50	-
Tube for temporary application <sup>1)</sup>	-	HRG 8	HRG 10	HRG 14
Setting tool for cracked and un-cracked concrete	SIW 14 A SIW 22 A	SIW 14 A, SIW 22A, SIW 22 T-A	SIW 22 T-A SIW9	SIW 22 T-A SIW9
Setting tool for solid brick and aerated concrete	-	SFH 22 A		
Setting tool for hollow core slab	SIW 14 A SIW 22 A	SIW 22 A		

1) Only for HUS3-H

### Setting parameters

Anchor size	6		8			10			14			
Type	HUS3-											
Nominal embedment depth	$h_{nom}$ [mm]	40	55	50	60	70	55	75	85	65	85	115
Minimum base material thickness	$h_{min}$ [mm]	80	100	100	100	120	100	130	140	120	160	200
Minimum spacing	$s_{min}$ [mm]	35		50	50	50	50	50	50	60	60	60
		35		40 $c \geq 50$								
Minimum edge distance	$c_{min}$ [mm]	35		40	40	40	50	50	50	60	60	60
Critical spacing for splitting failure	$s_{cr,sp}$ [mm]	120	126	120	140	170	130	180	220	170	200	280
Critical edge distance for splitting failure	$c_{cr,sp}$ [mm]	60	63	60	70	85	65	90	110	85	100	140
Critical spacing for concrete cone failure	$s_{cr,N}$ [mm]	3 $h_{ef}$										
Critical edge distance for concrete cone failure	$c_{cr,N}$ [mm]	1,5 $h_{ef}$										

For spacing (edge distance) smaller than critical spacing (critical edge distance) the design loads have to be reduced (see system design resistance).

Critical spacing and critical edge distance for splitting failure apply only for non-cracked concrete. For cracked concrete only the critical spacing and critical edge distance for concrete cone failure are decisive.

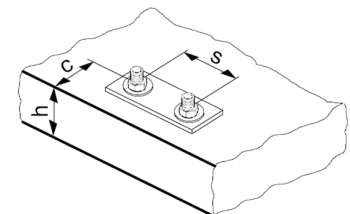

**Setting instructions**

\*For detailed information on installation see instruction for use given with the package of the product

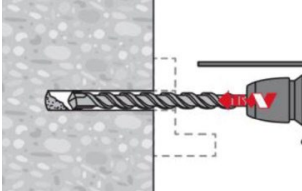
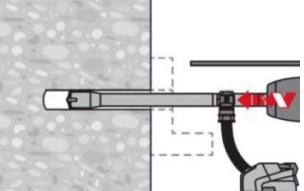
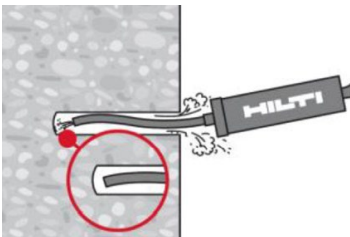
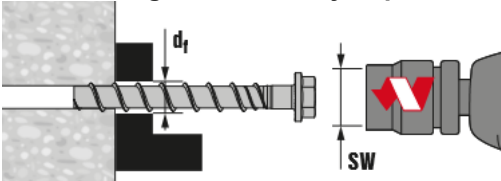
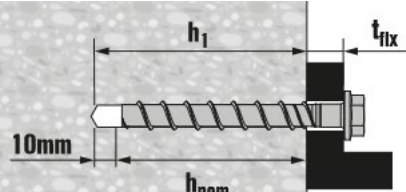
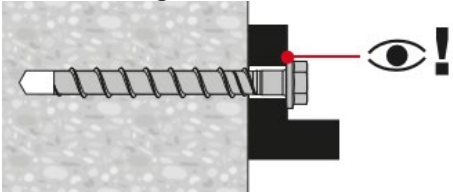
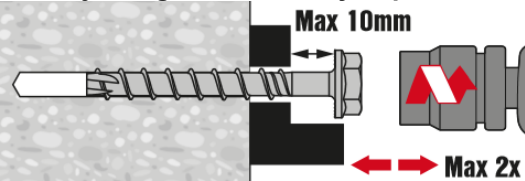
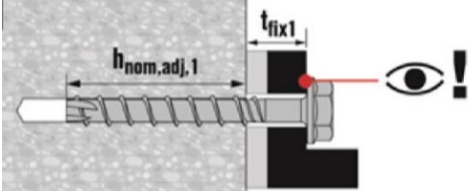
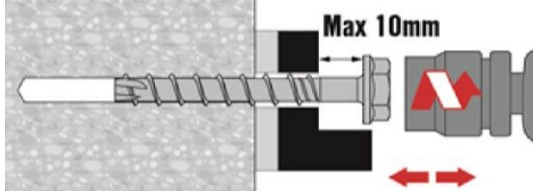
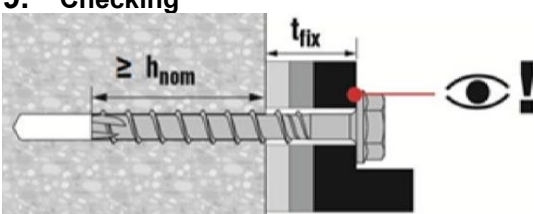
Setting instruction with adjustment	
<p><b>1a. Hammer drilling (HD):</b> Size 6 to 14</p> 	<p><b>1b. Hammer drilling with Hilti hollow drill bit (HDB):</b> Size 14 only. After drilling, proceed to fastener setting</p> 
<p><b>2. Cleaning</b></p> 	<p>Clean the drill hole. For sizes 6 and 8, hole cleaning is not required when 3x ventilation after drilling is executed and one of the following conditions is fulfilled:</p> <ul style="list-style-type: none"> <li>- drilling is in the vertical upwards orientation; or</li> <li>- drilling is in vertical downwards direction and the drilling depth is increased by additional 3*d<sub>0</sub>.</li> </ul> <p>For sizes 10 and 14, hole cleaning is not required when 3x ventilation after drilling is executed and one of the following conditions is fulfilled:</p> <ul style="list-style-type: none"> <li>- drilling is in the vertical upwards orientation; or</li> <li>- drilling is in vertical downwards or horizontal direction and the drilling depth is increased by additional 3*d<sub>0</sub>.</li> </ul> <p>1) moving the drill bit in and out of the drill hole 3 times after the recommended drilling depth h<sub>1</sub> is achieved. This procedure shall be done with both revolution and hammer functions activated in the drilling machine. For more details read the relevant MPII.</p> <p>2) it should be verified that the thickness of the concrete member in which the fastener is installed observes the minimum distance between the drilling end and the opposite end of the member, fulfilling the relation <math>h &gt; h_1 + \Delta h</math> with <math>\Delta h = \max(2 \cdot d_0; 30 \text{ mm})</math>.</p>
<p><b>3. Inserting the anchor by impact screw driver</b></p> 	<p><b>4. Anchor installed</b></p> 
<p><b>5. Checking</b></p> 	<p><b>6. Adjusting the anchor by impact screw driver</b></p> 
<p><b>7. Checking</b></p> 	<p><b>8. Adjusting the anchor by impact screw driver</b></p> 
<p><b>9. Checking</b></p> 	

The anchor can be adjusted max. two times.

The total allowed thickness of shims added during the adjustment process is 10 mm.

The final embedment depth after adjustment process must be larger or equal than h<sub>nom2</sub> or h<sub>nom3</sub>.

For size 14 only, hole cleaning is not required under specific conditions. Check instructions for use for more information.

**Basic loading data for temporary application in standard and fresh concrete <28 days old,  $f_{ck,cube} \geq 10 \text{ N/mm}^2$**

**All data in this section applies to the following conditions:**

- Strength class,  $f_{ck,cube} \geq 10 \text{ N/mm}^2$
- Only temporary use
- Screw is reusable, before each usage it must be checked according to Hilti instruction for use with the suited tube Hilti HRG
- Design resistance and recommended loads are valid for single anchor only
- Design resistance as well as recommended loads are valid for all load directions and valid for both cracked and non-cracked concrete
- Minimum base material thickness
- No edge distance and spacing influence
- Valid for HUS3-H only
- All data in this section for sizes 10 and 14 according to DIBt approval Z-21.8.2018 issue 2014-04-01
- All data in this section for size 8 according to Hilti Technical Data

**Design resistance**

		Hilti Tech. Data			DIBt approval Z-21.8-2018					
Anchor size HUS3-H		8			10			14		
Nominal embedment depth	$h_{nom}$ [mm]	50	60	70	55	75	85	65	85	115
Cracked and non-cracked concrete										
Tensile $N_{rd}$ =	$f_{ck,cube} \geq 10 \text{ N/mm}^2$ [kN]	2,5	3,2	4,7	3,3	5,3	6,3	4,4	7,0	12,3
	$f_{ck,cube} \geq 15 \text{ N/mm}^2$ [kN]	3,1	4,0	5,7	4,0	6,4	7,8	5,4	8,5	15,0
Shear $V_{rd}$	$f_{ck,cube} \geq 20 \text{ N/mm}^2$ [kN]	3,6	4,6	6,6	4,7	7,4	9,0	6,2	9,9	17,3

**Recommended load <sup>a)</sup>**

		Hilti Tech. Data			DIBt approval Z-21.8-2018					
Anchor size HUS3-H		8			10			14		
Nominal embedment depth	$h_{nom}$ [mm]	50	60	70	55	75	85	65	85	115
Tensile $N_{rec}$ =	$f_{ck,cube} \geq 10 \text{ N/mm}^2$ [kN]	1,8	2,3	3,4	2,4	3,8	4,5	3,1	5,0	8,8
	$f_{ck,cube} \geq 15 \text{ N/mm}^2$ [kN]	2,2	2,9	4,1	2,9	4,6	5,5	3,8	6,1	10,7
Shear $V_{rec}$	$f_{ck,cube} \geq 20 \text{ N/mm}^2$ [kN]	2,6	3,3	4,7	3,3	5,3	6,4	4,4	7,1	12,4

a) With overall partial safety factor for action  $\gamma = 1,4$ . The partial safety factors for action depend on the type of loading and shall be taken from national regulations.

## Setting information

### Setting details

		Hilti			DIBt approval Z-21.8-2018					
Anchor size	HUS3-H	8			10			14		
Nominal anchorage depth	$h_{nom}$ [mm]	50	60	70	55	75	85	65	85	115
Minimum base material thickness	$h_{min}$ [mm]	100	115	145	115	150	175	130	175	255
Minimum spacing	$s_{min}$ [mm]	180	225	285	225	300	345	255	345	510
Minimum edge distance direction 1	$c_1$ [mm]	60	75	95	75	100	115	85	115	170
Minimum edge distance direction 2	$c_2$ [mm]	95	115	145	115	150	175	130	180	260

### Setting parameters

		Hilti			DIBt approval Z-21.8-2018					
Anchor size	HUS3-H	8			10			14		
Nominal anchorage depth	$h_{nom}$ [mm]	50	60	70	55	75	85	65	85	115
Nominal diameter of drill bit	$d_o$ [mm]	8			10			14		
Cutting diameter of drill bit	$d_{cut} \leq$ [mm]	8,45			10,45			14,50		
Depth of drill bit	$h_1 \leq$ [mm]	60	70	80	65	85	95	75	95	125
Diameter of clearance hole in the fixture	$d_r \leq$ [mm]	12			14			18		
Width across	SW [mm]	13			15			21		
Impact screw driver		Hilti SIW 22 T-A								
Suited tube		Hilti HRG 8			Hilti HRG 10			Hilti HRG 14		

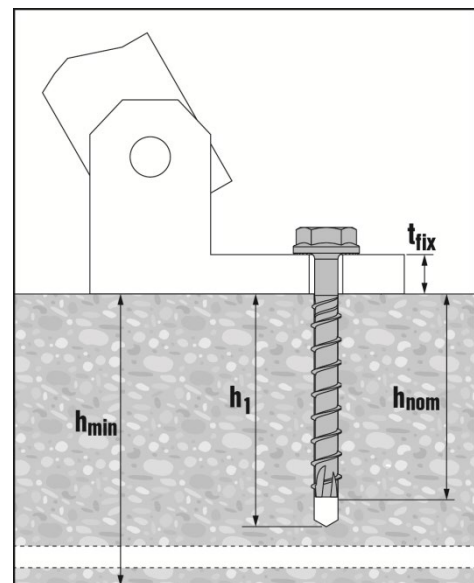
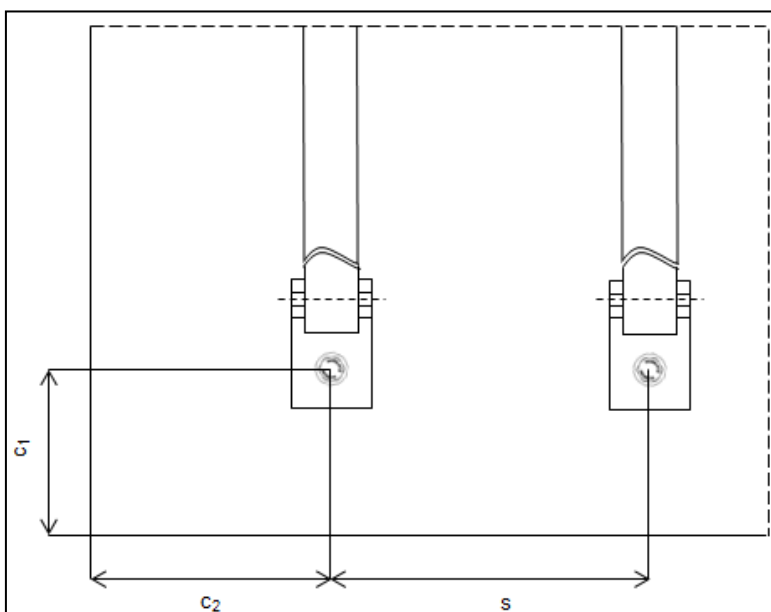

**Tube specification**

Anchor size / tube		8 / HRG 8	10 / HRG 10	14 / HRG 14
Inner tube diameter	$\varnothing_i$ [mm]	9,7	11,7	16,0
Outer tube diameter	$\varnothing_e$ [mm]	15,0	17,0	22,0
Tube length	Lt [mm]	23,0	28,0	40,3

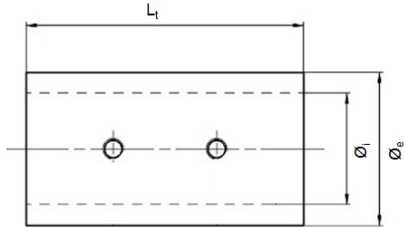

**Setting instructions**

\*For detailed information on installation see instruction for use given with the package of the product

Instruction for use – re-use of screw	
<p><b>1. Removing the anchor with Screw-driver</b></p>	<p><b>2. Removing the anchor</b></p>
<p><b>3. Checking with tube Hilti HRG</b></p>	<p><b>4. Checking with tube Hilti HRG</b></p>
<p><b>5. Drilling</b></p>	<p><b>6. Reinstall based on setting instructions</b></p>

## Basic loading data (for a single anchor) in solid masonry units



### All data in this section applies to:

- Load values valid for holes drilled with TE rotary hammers in hammering mod
- Correct anchor setting (see instruction for use, setting details)
- The core/material ratio may not exceed 15 % of a bed joint area
- The brim area around holes must be at least 70mm
- Edge distances, spacing and other influences, see below
- All data given in this section according to Hilti Technical Data

### Nominal embedment depth

Anchor size		6	8	10
Nominal embedment depth	$h_{nom}$ [mm]	55	60	75

### Recommended loads for HUS3

Anchor size			6	8	10
			A, H, I, C, P, PS, PL	H, C, HF	H, C, HF
		Compressive strength class [N/mm <sup>2</sup> ]	F <sub>rec</sub> Tensile and shear loads		
	Solid clay brick Mz 12/2,0	≥ 8	0,6	-	-
		≥ 10	0,7	-	-
		≥ 12	0,8	1,1	1,4
	DIN 105 / EN 771-1	≥ 16	0,9	-	-
		≥ 20	0,9	1,6	2,0
	Solid sand-lime brick Mz 12/2,0	≥ 8	0,8	-	-
		≥ 10	0,9	-	-
		≥ 12	1,0	1,3	1,4
	DIN 106/EN 771-2	≥ 16	1,1	-	-
		≥ 20	1,2	1,7	2,1
	Aerated concrete PPW 6-0,4	≥ 6	0,4	0,7	0,9
	DIN 4165/EN 771-4				

## Permissible anchor location in brick and block walls

### Edge distance and spacing influence

- The technical data for HUS3 anchors are reference loads for MZ 12, KS 12 and PPW 6. Due to the large variation of natural stone slid bricks, on site anchor testing is recommended to validate technical data
- The HUS3 anchor was installed and tested in center of solid bricks as shown. The HUS3 anchor was not tested in the mortar joint between solid bricks or in hollow bricks, however a load reduction is expected
- For brick walls where anchor position in brick can not be determined, 100 % anchor testing is recommended
- Distance to free edge free edge to solid masonry (Mz and KS) units ≥ 200mm
- Distance to free edge free edge to solid masonry (autoclaved aerated gas concrete) units ≥ 170mm
- The minimum distance to horizontal and vertical mortar joint ( $c_{min}$ ) is started in drawing below
- Minimum anchor spacing ( $s_{min}$ ) in one brick/block is ≥ 80 mm



### Limits

- All data is for multiple use for non-structural applications
- Plaster, graveling, lining or levelling courses are regarded as non-bearing and may not be taken into account for the calculation of embedment depth
- The decisive resistance to tension loads is the lower value of  $N_{rec}$  (brick breakout, pull out) and  $N_{max,pb}$  (pull out of one brick)

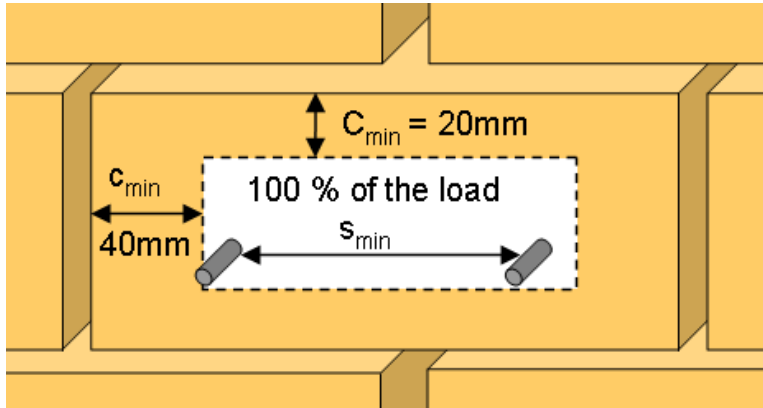

### Basic loading data for single anchor in Hollow core slab

#### All data in this section applies to

- Correct setting (See setting instruction)
- No edge distance and spacing influence
- Ratio core width / web thickness  $w/e \leq 4,2$
- Concrete C 30/37 to C 50/60

#### Characteristic resistance

Anchor size			8	10
Type	HUS3		C, H, HF	C, H, HF
Bottom flange thickness	$d_b \geq$	[mm]	30	30
All load directions	$F_{Rk}$	[kN]	2,0	2,0

#### Design resistance

Anchor size			8	10
Type	HUS3		C, H, HF	C, H, HF
Bottom flange thickness	$d_b \geq$	[mm]	30	30
All load directions	$F_{Rd}$	[kN]	1,3	1,3

#### Recommended loads

Anchor size			8	10
Type	HUS3		C, H, HF	C, H, HF
Bottom flange thickness	$d_b \geq$	[mm]	30	30
All load directions <sup>a)</sup>	$F_{rec}$	[kN]	0,95	0,95

a) With overall partial safety factor for action  $\gamma = 1,4$ . The partial safety factors for action depend on the type of loading and shall be taken from national regulations.

Anchor Type	Size [mm]	Length [mm]	$d_b=30$ [mm]		$d_b=35$ [mm]		$d_b=40$ [mm]		$d_b=50$ [mm]	
			$t_{fix,min}$ [mm]	$t_{fix,max}$ [mm]	$t_{fix,min}$ [mm]	$t_{fix,max}$ [mm]	$t_{fix,min}$ [mm]	$t_{fix,max}$ [mm]	$t_{fix,min}$ [mm]	$t_{fix,max}$ [mm]
HUS3-H	8	55	5	15	5	10	5	5	5	5
		65	5	25	5	20	5	15	5	5
		75	5	35	5	30	5	25	5	15
		85	15	45	15	40	15	35	15	25
		100	30	60	30	55	30	50	30	40
		120	50	80	50	75	50	70	50	60
		150	80	110	80	105	80	100	80	90
HUS3-HF	8	65	5	25	5	20	5	15	5	5
		75	5	35	5	30	5	25	5	15
		85	15	45	15	40	15	35	15	25
		100	30	60	30	55	30	50	30	40
HUS3-C	8	65	15	25	15	20	15	15	15	5
		75	15	35	15	30	15	25	15	15
		85	15	45	15	40	15	35	15	25
HUS3-H	10	60	5	15	5	10	5	5	5	5
		70	15	25	15	20	15	15	15	5
		80	5	35	5	30	5	25	5	15
		90	5	45	5	40	5	35	5	25
		100	15	55	15	50	15	45	15	35
		110	25	65	25	60	25	55	25	45
		130	45	85	45	80	45	75	45	65
HUS3-HF	10	60	5	15	5	10	5	5	5	5
		80	5	35	5	30	5	25	5	15
		100	15	55	15	50	15	45	15	35
		110	25	65	25	60	25	55	25	45
HUS3-C	10	70	15	25	15	20	15	15	15	10
		90	15	45	15	40	15	35	15	25
		100	15	55	15	50	15	45	15	35

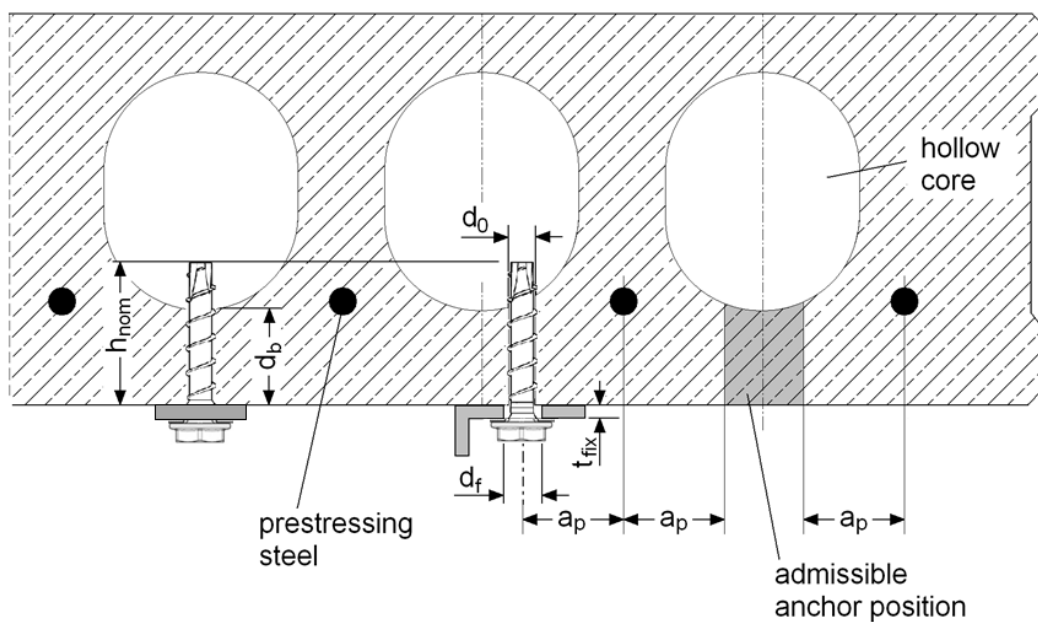

**Anchor spacing and edge distance**

Anchor size		8	10
Type	HUS3	C, H, HF	C, H, HF
Minimum edge distance	$c_{min} \geq$ [mm]	100	
Minimum anchor spacing	$s_{min} \geq$ [mm]	100	
Minimum distance between anchor groups	$a_{min} \geq$ [mm]	100	

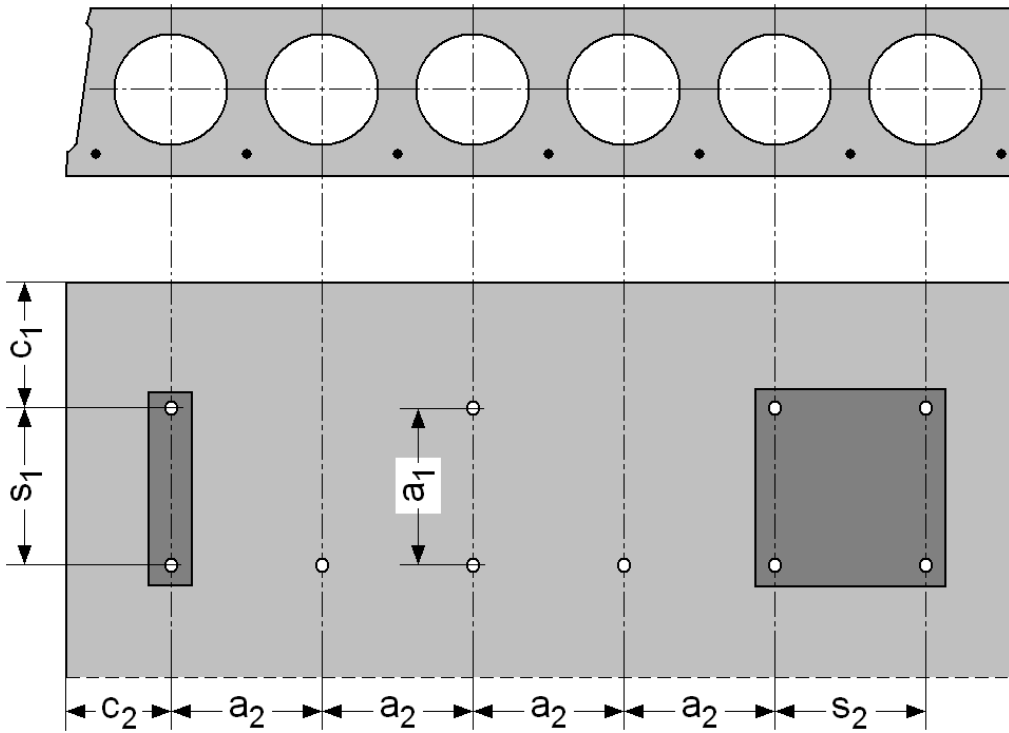

## Setting instructions

\*For detailed information on installation see instruction for use given with the package of the product

### Installation in hollow core slabs

#### 1. Checking the anchor with tube Hilti HSB

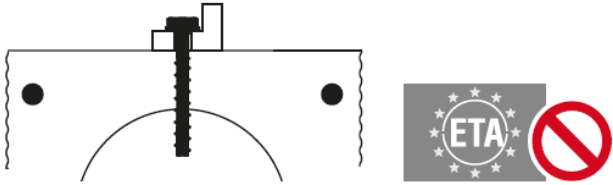

#### 2. Positioning pre-stressed steel

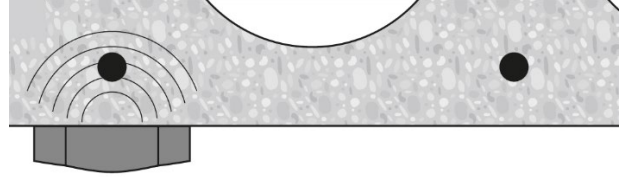

#### 3. Marking pre-stressed steel position

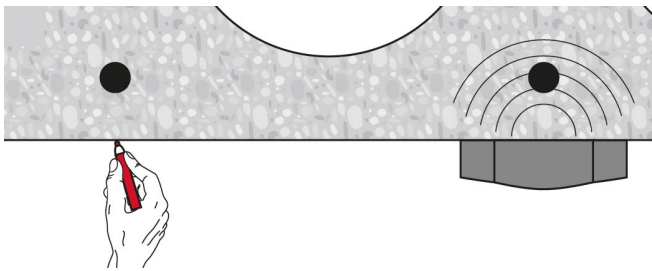

#### 4. Marking pre-stressed steel position

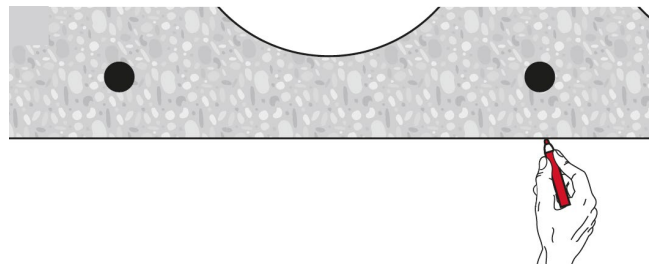

#### 5. Drilling

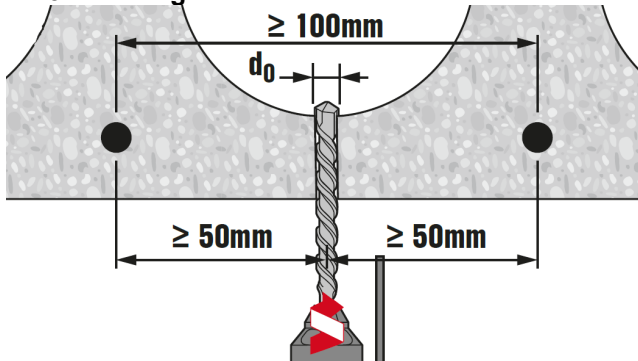

#### 6. Setting the anchor

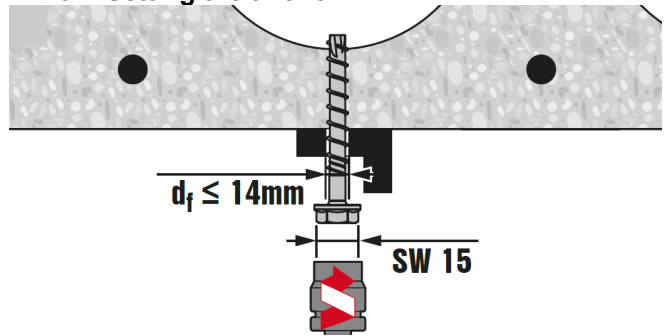

#### 7. Setting the anchor

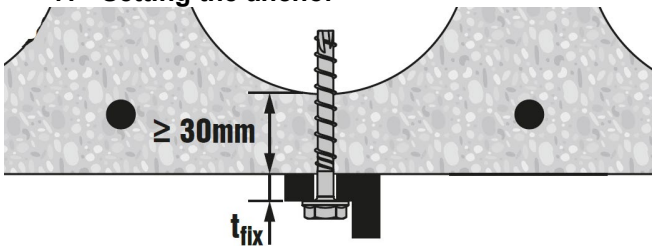

#### 8. Checking

