

MM skinneresystem

Vingemutter MM-WN

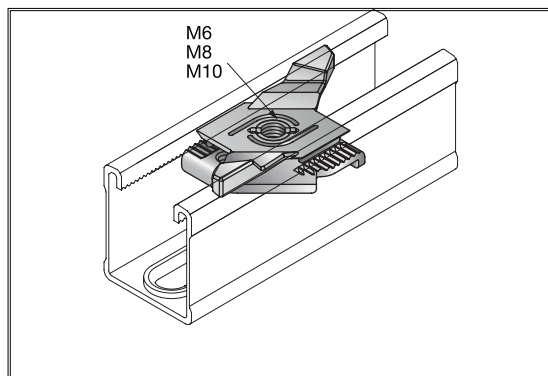

Bruksområde

- For å feste MM-AH-90 til skinne
- For å feste ting flatt mot skinneprofil

Egenskaper

- Vingemutter med skive. Klar til bolt/feste
- Tagget skinneprofil og skive for stabil feste

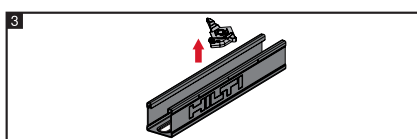
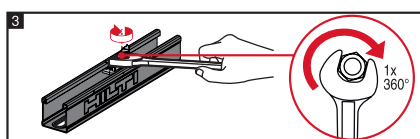
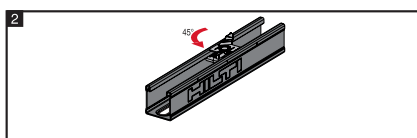
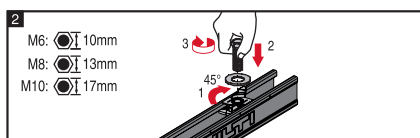
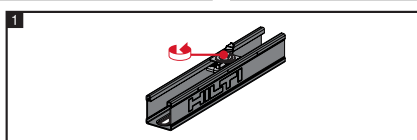
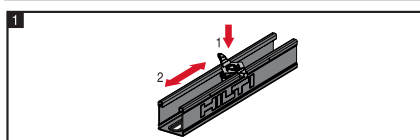
Materialer

Metall: DC04/ EN 10130

Plast: PA

Korrosjonsbeskyttelse

Elsink

Skinnetype

Skinne 1: MM-C-16/ MM-C-30

Skinne 2: MM-C-36/ MM-C-45

Artikkeltype	Anbefalt strekklast (kN)		Anbefalt skjærlast (kN)		Tilstrammingsmoment Nm
	Skinne 1	Skinne 2	Skinne 1	Skinne 2	
MM-WN M6	1,2	1,2	0,7	1,0	5
MM-WN M8	1,2	1,2	1,0	1,0	5
MM-WN M10	1,2	1,2	1,0	1,0	5

Artikkelnummer	Gjengestuss	Vekt gram	Navn	Antall eske	Salgsantall
418764	M6	9,3g	Vingemutter MM-WN M6	50	
7418765	M8	9,6g	Vingemutter MM-WN M8	50	1
7418766	M10	9,2g	Vingemutter MM-WN M10	50	1